

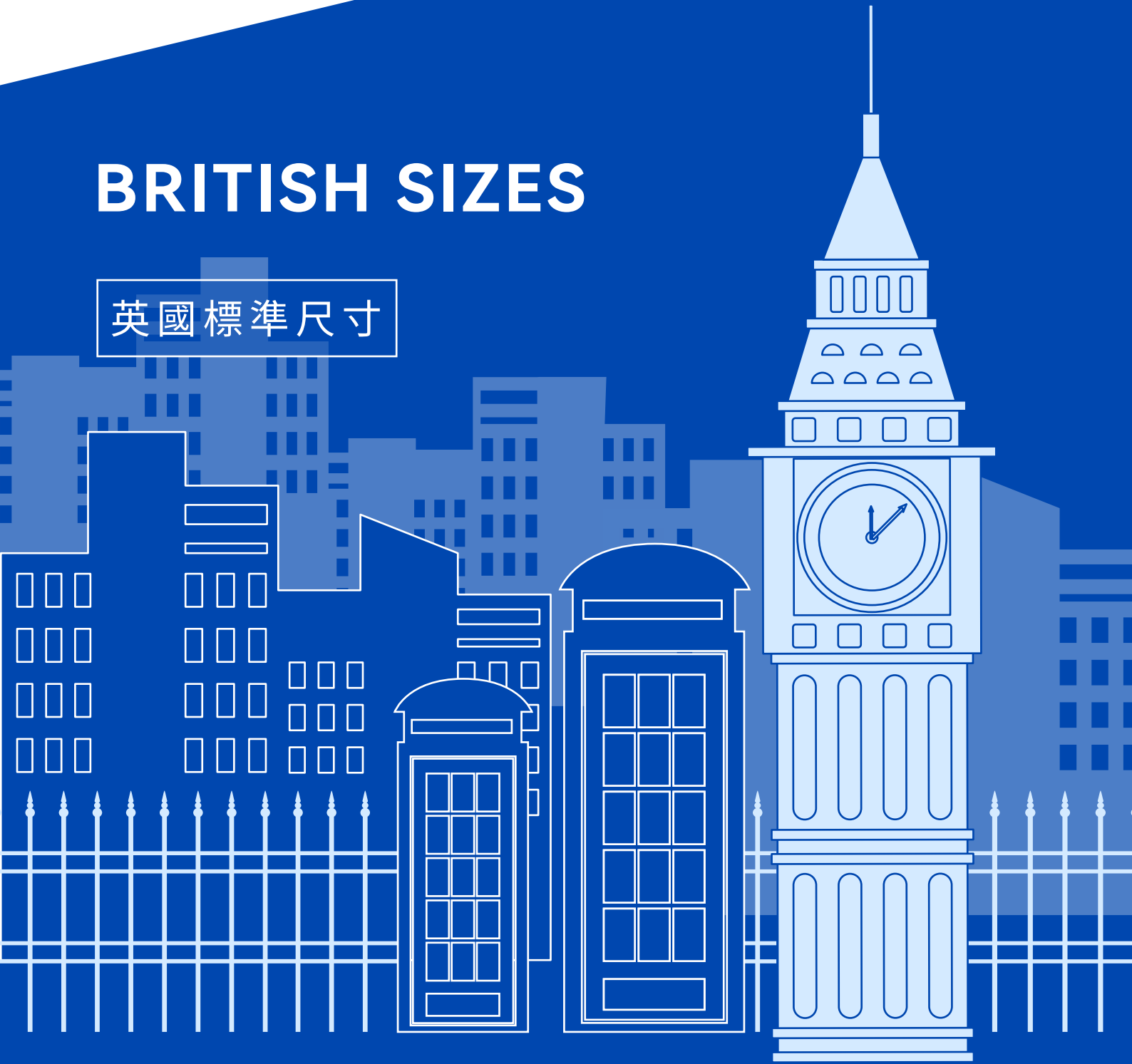

煌港
特鋼
PEAK KONG
SPECIAL STEEL

BRITISH SIZES

英國標準尺寸



STEEL LASER WELDING PROFILES

Tel: +852-29811161

Email: sales@peakkong.com

Phone: +852-92999655

WhatsApp/WeChat: 92999655

工字鋼 Universal Beams

Profiles are laser fused with full penetration, equivalent to hot rolled. 型材採用激光熔透，等同於熱軋。

- 尺寸：符合BS 4-1: 1993
- 公差：EN 10034:1993 • 等級：符合BS EN 10025-2:2004
- Dimension: in accordance with BS 4-1: 1993
- Tolerance: EN 10034:1993 • Grade: according to BS EN 10025-2:2004

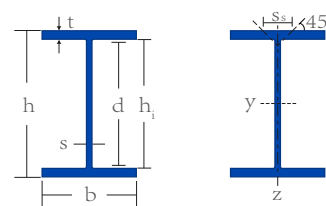

尺寸 Designation	單位重量 Mass per Unit Length	高度 Depth of Section	寬度 Width of Section	腰厚 Web Thickness	腿厚 Flange Thickness	h ₁ (mm)	d(mm)
	kg/m	h(mm)	b(mm)	s(mm)	t(mm)		
UB 127 x 76 x 13	13	127	76	4	7.6	112	96.6
UB 152 x 89 x 16	16	152.4	88.7	4.5	7.7	137	121.8
UB 178 x 102 x 19	19	177.8	101.2	4.8	7.9	162	146.8
UB 203 x 102 x 23	23.1	203.2	101.8	5.4	9.3	184.6	169.4
UB 203 x 133 x 25	25.1	203.2	133.2	5.7	7.8	187.6	172.4
UB 203 x 133 x 31	30	206.8	133.9	6.4	9.6	187.6	172.4
UB 254 x 102 x 22	22	254	101.6	5.7	6.8	240.4	225.2
UB 254 x 102 x 25	25.2	257.2	101.9	6	8.4	240.4	225.2
UB 254 x 102 x 28	28.3	260.4	102.2	6.3	10	240.4	225.2
UB 254 x 146 x 31	31.1	251.4	146.1	6	8.6	234.2	219
UB 254 x 146 x 37	37.0	256	146.4	6.3	10.9	234.2	219
UB 254 x 146 x 43	43.0	259.6	147.3	7.2	12.7	234.2	219
UB 305 x 102 x 25	24.8	305.1	101.6	5.8	7	291.1	275.9
UB 305 x 102 x 28	28.2	308.7	101.8	6	8.8	291.1	275.9
UB 305 x 102 x 33	32.8	312.7	102.4	6.6	10.8	291.1	275.9
UB 305 x 127 x 37	37.0	304.4	123.4	7.1	10.7	283	265.2
UB 305 x 127 x 42	41.9	307.2	124.3	8	12.1	283	265.2
UB 305 x 127 x 48	48.1	311	125.3	9	14	283	265.2
UB 305 x 165 x 40	40.3	303.4	165	6	10.2	283	265.2
UB 305 x 165 x 46	46.1	306.6	165.7	6.7	11.8	283	265.2
UB 305 x 165 x 54	54.0	310.4	166.9	7.9	13.7	283	265.2
UB 356 x 127 x 33	33.1	349	125.4	6	8.5	332	311.6
UB 356 x 127 x 39	39.1	353.4	126	6.6	10.7	332	311.6
UB 356 x 171 x 45	45.0	351.4	171.1	7	9.7	332	311.6
UB 356 x 171 x 51	51.0	355	171.5	7.4	11.5	332	311.6
UB 356 x 171 x 57	57.0	358	172.2	8.1	13	332	311.6
UB 356 x 171 x 67	67.1	363.4	173.2	9.1	15.7	332	311.6
UB 406 x 140 x 39	39.0	398	141.8	6.4	8.6	380.8	360.4
UB 406 x 140 x 46	46.0	403.2	142.2	6.8	11.2	380.8	360.4
UB 406 x 178 x 54	54.1	402.6	177.7	7.7	10.9	380.8	360.4
UB 406 x 178 x 60	60.1	406.4	177.9	7.9	12.8	380.8	360.4
UB 406 x 178 x 67	67.1	409.4	178.8	8.8	14.3	380.8	360.4
UB 406 x 178 x 74	74.2	412.8	179.5	9.5	16	380.8	360.4
UB 457 x 152 x 52	52.3	449.8	152.4	7.6	10.9	428	407.6
UB 457 x 152 x 60	59.8	454.6	152.9	8.1	13.3	428	407.6
UB 457 x 152 x 67	67.2	458	153.8	9	15	428	407.6
UB 457 x 152 x 74	74.2	462	154.4	9.6	17	428	407.6
UB 457 x 152 x 82	82.1	465.8	155.3	10.5	18.9	428	407.6
UB 457 x 191 x 67	67.1	453.4	189.9	8.5	12.7	428	407.6
UB 457 x 191 x 74	74.3	457	190.4	9	14.5	428	407.6
UB 457 x 191 x 82	82.0	460	191.3	9.9	16	428	407.6
UB 457 x 191 x 89	89.3	463.4	191.9	10.5	17.7	428	407.6
UB 457 x 191 x 98	98.3	467.2	192.8	11.4	19.6	428	407.6

工字鋼 Universal Beams

Profiles are laser fused with full penetration, equivalent to hot rolled. 型材採用激光熔透，等同於熱軋。

- 尺寸：符合BS 4-1: 1993
- 公差：EN 10034:1993 • 等級：符合BS EN 10025-2:2004
- Dimension: in accordance with BS 4-1: 1993
- Tolerance: EN 10034:1993 • Grade: according to BS EN 10025-2:2004

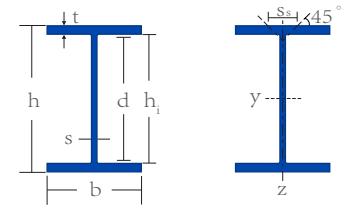

尺寸 Designation	I_y	W_{ely}	W_{ply}	i_y	A_{vz}	I_z	W_{elz}	W_{plz}	i_z	S_s	I_t	I_w
	$mm^4 \times 10^4$	$mm^3 \times 10^3$	$mm^3 \times 10^3$	$mm \times 10$	$mm^2 \times 10^2$	$mm^4 \times 10^4$	$mm^3 \times 10^3$	$mm^3 \times 10^3$	$mm \times 10$	mm	$mm^4 \times 10^4$	$mm^6 \times 10^9$
UB 127 x 76 x 13	473	74.56	84.15	5.35	6.43	55.74	14.67	22.58	1.84	28.10	2.80	1.98
UB 152 x 89 x 16	834	109.5	123.3	6.41	8.18	89.75	20.24	31.18	2.10	28.80	3.55	4.69
UB 178 x 102 x 19	1356	152.5	171.3	7.48	9.85	136.7	27.02	41.59	2.37	29.50	4.42	9.85
UB 203 x 102 x 23	2105	207.2	234.1	8.46	12.38	163.9	32.19	49.75	2.36	32.90	7.02	15.37
UB 203 x 133 x 25	2340	230.3	257.7	8.56	12.82	307.6	46.19	70.94	3.10	30.20	6.10	29.33
UB 203 x 133 x 31	2896	280.0	314.4	8.71	14.58	384.7	57.45	88.22	3.17	34.50	10.43	37.34
UB 254 x 102 x 22	2841	223.7	259.0	10.07	15.62	119.3	23.49	37.27	2.06	28.20	4.35	18.16
UB 254 x 102 x 25	3415	265.5	305.5	10.32	16.70	148.7	29.18	46.01	2.15	31.70	6.56	22.92
UB 254 x 102 x 28	4005	307.6	352.8	10.54	17.79	178.5	34.94	54.85	2.22	35.20	9.66	27.89
UB 254 x 146 x 31	4413	351.1	393.1	10.55	16.37	447.5	61.26	94.13	3.36	32.10	8.68	65.88
UB 254 x 146 x 37	5537	432.6	483.2	10.83	17.59	570.6	77.96	119.4	3.48	37.00	15.37	85.61
UB 254 x 146 x 43	6544	504.1	566.3	10.93	20.20	677.4	91.97	141.1	3.52	41.50	23.97	103.1
UB 305 x 102 x 25	4455	292.1	342.0	11.87	18.85	122.9	24.20	38.81	1.97	28.70	4.98	27.18
UB 305 x 102 x 28	5366	347.6	402.9	12.23	19.83	155.4	30.53	48.45	2.08	32.50	7.51	34.79
UB 305 x 102 x 33	6501	415.8	480.8	12.47	22.06	194.1	37.91	60.04	2.15	37.10	12.29	44.04
UB 305 x 127 x 37	7171	471.1	539.4	12.33	23.44	336.2	54.49	85.41	2.67	38.93	14.96	72.26
UB 305 x 127 x 42	8196	533.6	613.5	12.39	26.44	388.8	62.55	98.41	2.70	42.63	21.42	84.32
UB 305 x 127 x 48	9575	615.7	710.7	12.50	29.90	461.0	73.59	116.1	2.74	47.43	32.18	101.2
UB 305 x 165 x 40	8503	560.5	623.1	12.87	20.09	764.4	92.65	141.7	3.86	36.83	14.74	164.1
UB 305 x 165 x 46	9899	645.7	720.0	12.98	22.53	895.7	108.1	165.5	3.90	40.73	22.20	194.4
UB 305 x 165 x 54	11700	753.6	846.1	13.04	26.56	1063	127.4	195.6	3.93	45.73	34.90	233.6
UB 356 x 127 x 33	8249	472.7	542.9	13.99	23.06	280.2	44.69	70.29	2.58	34.95	8.97	80.97
UB 356 x 127 x 39	10172	575.6	658.5	14.30	25.69	357.8	56.80	89.05	2.68	39.95	15.15	104.7
UB 356 x 171 x 45	12070	686.7	774.6	14.51	26.79	811.1	94.81	146.6	3.76	38.35	16.16	236.4
UB 356 x 171 x 51	14140	796.4	896.0	14.76	28.66	968.3	112.9	174.2	3.86	42.35	24.00	285.2
UB 356 x 171 x 57	16040	896.0	1010	14.87	31.49	1108	128.7	198.8	3.91	46.05	33.59	329.2
UB 356 x 171 x 67	19460	1071	1211	15.09	35.74	1362	157.3	243.0	3.99	52.45	55.90	410.9
UB 406 x 140 x 39	12508	628.6	723.6	15.87	27.57	409.8	57.80	90.85	2.87	35.55	10.99	154.9
UB 406 x 140 x 46	15685	778.0	887.6	16.35	29.83	538.1	75.68	118.1	3.03	41.15	19.07	206.2
UB 406 x 178 x 54	18720	930.0	1055	16.48	33.28	1021	114.9	178.3	3.85	41.45	23.50	391.0
UB 406 x 178 x 60	21600	1063	1199	16.80	34.60	1203	135.3	209.0	3.97	45.45	33.49	465.2
UB 406 x 178 x 67	24330	1189	1346	16.87	38.58	1365	152.7	236.6	3.99	49.35	46.40	531.7
UB 406 x 178 x 74	27310	1323	1501	17.00	41.85	1545	172.2	267.0	4.04	53.45	63.10	607.1
UB 457 x 152 x 52	21370	950.0	1096	17.91	36.47	645.0	84.64	133.3	3.11	41.35	21.71	309.7
UB 457 x 152 x 60	25500	1122	1287	18.29	39.35	794.6	103.9	163.1	3.23	46.65	34.02	385.8
UB 457 x 152 x 67	28930	1263	1453	18.39	43.82	912.6	118.7	186.7	3.27	50.95	47.95	446.2
UB 457 x 152 x 74	32670	1414	1627	18.60	47.08	1047	135.6	213.1	3.33	55.55	66.18	516.3
UB 457 x 152 x 82	36590	1571	1811	18.71	51.67	1185	152.5	240.4	3.37	60.25	89.65	589.1
UB 457 x 191 x 67	29380	1296	1471	18.54	40.94	1452	152.9	237.3	4.12	45.85	37.54	703.8
UB 457 x 191 x 74	33320	1458	1653	18.76	43.68	1671	175.5	272.1	4.20	49.95	52.14	816.6
UB 457 x 191 x 82	37050	1611	1831	18.83	48.11	1871	195.6	303.9	4.23	53.85	69.72	920.1
UB 457 x 191 x 89	41020	1770	2014	18.99	51.30	2089	217.8	338.4	4.29	57.85	91.26	1035
UB 457 x 191 x 98	45730	1957	2232	19.11	55.92	2347	243.5	378.9	4.33	62.55	122.1	1173

工字鋼(續) Universal Beams(Continued)

Profiles are laser fused with full penetration, equivalent to hot rolled. 型材採用激光熔透，等同於熱軋。

- 尺寸: 符合BS 4-1: 1993
- 公差: EN 10034:1993 • 等級: 符合BS EN 10025-2:2004
- Dimension: in accordance with BS 4-1: 1993
- Tolerance: EN 10034:1993 • Grade: according to BS EN 10025-2:2004

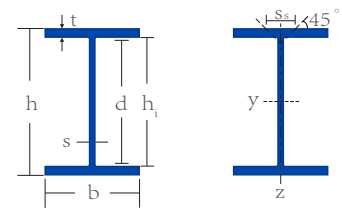

尺寸 Designation	單位重量 Mass per Unit Length	高度 Depth of Section	寬度 Width of Section	腰厚 Web Thickness	腿厚 Flange Thickness	h ₁ (mm)	d(mm)
	kg/m	h(mm)	b(mm)	s(mm)	t(mm)		
UB 533 x 210 x 82	82.2	528.3	208.8	9.6	13.2	501.9	476.5
UB 533 x 210 x 92	92.1	533.1	209.3	10.1	15.6	501.9	476.5
UB 533 x 210 x 101	101.0	536.7	210	10.8	17.4	501.9	476.5
UB 533 x 210 x 109	109.0	539.5	210.8	11.6	18.8	501.9	476.5
UB 533 x 210 x 122	122.0	544.5	211.9	12.7	21.3	501.9	476.5
UB 610 x 229 x 101	101.2	602.6	227.6	10.5	14.8	573	547.6
UB 610 x 229 x 113	113.0	607.6	228.2	11.1	17.3	573	547.6
UB 610 x 229 x 125	125.1	612.2	229	11.9	19.6	573	547.6
UB 610 x 229 x 140	139.9	617.2	230.2	13.1	22.1	573	547.6
UB 610 x 305 x 149	149.1	612.4	304.8	11.8	19.7	573	540
UB 610 x 305 x 179	179.0	620.2	307.1	14.1	23.6	573	540
UB 610 x 305 x 238	238.1	635.8	311.4	18.4	31.4	573	540
UB 686 x 254 x 125	125.2	677.9	253	11.7	16.2	645.5	615.1
UB 686 x 254 x 140	140.1	683.5	253.7	12.4	19	645.5	615.1
UB 686 x 254 x 152	152.4	687.5	254.5	13.2	21	645.5	615.1
UB 686 x 254 x 170	170.2	692.9	255.8	14.5	23.7	645.5	615.1
UB 762 x 267 x 147	146.9	754	265.2	12.8	17.5	719	686
UB 762 x 267 x 173	173.0	762.2	266.7	14.3	21.6	719	686
UB 762 x 267 x 197	196.8	769.8	268	15.6	25.4	719	686
UB 838 x 292 x 176	175.9	834.9	291.7	14	18.8	797.3	761.7
UB 838 x 292 x 194	193.8	840.7	292.4	14.7	21.7	797.3	761.7
UB 838 x 292 x 226	226.5	850.9	293.8	16.1	26.8	797.3	761.7
UB 914 x 305 x 201	200.9	903	303.3	15.1	20.2	862.6	824.4
UB 914 x 305 x 224	224.2	910.4	304.1	15.9	23.9	862.6	824.4
UB 914 x 305 x 253	253.4	918.4	305.5	17.3	27.9	862.6	824.4
UB 914 x 305 x 289	289.1	926.6	307.7	19.5	32	862.6	824.4
UB 914 x 419 x 343	343.3	911.8	418.5	19.4	32	847.8	799.6
UB 914 x 419 x 388	388.0	921	420.5	21.4	36.6	847.8	799.6
UB 1016 x 305 x 222	222.0	970.3	300	16	21.1	928	868
UB 1016 x 305 x 249	249.0	980	300	16.5	26	928	868
UB 1016 x 305 x 272	272.0	990.1	300	16.5	31	928	868
UB 1016 x 305 x 314	314.0	1000	300	19.1	35.9	928	868
UB 1016 x 305 x 349	349.0	1008.1	302	21.1	40	928	868
UB 1016 x 305 x 393	393.0	1016	303	24.4	43.9	928	868
UB 1016 x 305 x 415	415.0	1020	304	26	46	928	868
UB 1016 x 305 x 438	438.0	1026	305	27	49	928	868
UB 1016 x 305 x 494	494.0	1036	309	31	54	928	868
UB 1016 x 305 x 584	584.0	1056	314	36	64	928	868

工字鋼 (續) Universal Beams (Continued)

Profiles are laser fused with full penetration, equivalent to hot rolled. 型材採用激光熔透，等同於熱軋。

- 尺寸: 符合BS 4-1: 1993
- 公差: EN 10034:1993 • 等級: 符合BS EN 10025-2:2004
- Dimension: in accordance with BS 4-1: 1993
- Tolerance: EN 10034:1993 • Grade: according to BS EN 10025-2:2004

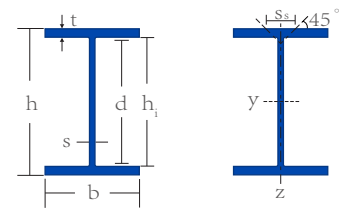

尺寸 Designation	I_y	W_{ely}	W_{ply}	i_y	A_{vz}	I_z	W_{elz}	W_{plz}	i_z	S_s	I_t	I_w
	$mm^4 \times 10^4$	$mm^3 \times 10^3$	$mm^3 \times 10^3$	$mm \times 10$	$mm^2 \times 10^2$	$mm^4 \times 10^4$	$mm^3 \times 10^3$	$mm^3 \times 10^3$	$mm \times 10$	mm	$mm^4 \times 10^4$	$mm^6 \times 10^9$
UB 533 x 210 x 82	47540	1800	2059	21.31	54.19	2007	192.3	300.4	4.38	50.88	52.54	1328
UB 533 x 210 x 92	55230	2072	2360	21.69	57.61	2389	228.3	355.6	4.51	56.18	76.34	1596
UB 533 x 210 x 101	61520	2292	2612	21.87	61.89	2692	256.4	399.4	4.57	60.48	101.6	1811
UB 533 x 210 x 109	66820	2477	2828	21.94	66.56	2943	279.2	435.8	4.60	64.08	127.3	1989
UB 533 x 210 x 122	76040	2793	3196	22.12	73.24	3388	319.7	499.7	4.67	70.18	179.6	2312
UB 610 x 229 x 101	75780	2515	2881	24.24	66.86	2915	256.1	400.2	4.75	54.98	78.16	2512
UB 610 x 229 x 113	87320	2874	3281	24.63	71.30	3434	301.0	469.3	4.88	60.58	112.3	2985
UB 610 x 229 x 125	98610	3221	3676	24.88	76.88	3932	343.4	535.4	4.97	65.98	155.2	3444
UB 610 x 229 x 140	111800	3622	4142	25.05	84.96	4505	391.4	611.4	5.03	72.18	217.8	3978
UB 610 x 305 x 149	125900	4111	4594	25.74	78.78	9308	610.7	937.3	7.00	70.53	200.4	8165
UB 610 x 305 x 179	153000	4935	5547	25.90	94.25	11408	743.0	1144	7.07	80.63	341.6	10140
UB 610 x 305 x 238	209500	6589	7486	26.28	123.9	15837	1017	1574	7.23	100.5	790.6	14430
UB 686 x 254 x 125	118000	3481	3994	27.20	84.33	4383	346.5	542.4	5.24	61.91	118.3	4786
UB 686 x 254 x 140	136300	3987	4558	27.64	90.16	5183	408.6	638.2	5.39	68.21	170.3	5708
UB 686 x 254 x 152	150400	4374	5000	27.83	96.35	5784	454.5	710.2	5.46	73.01	221.3	6407
UB 686 x 254 x 170	170300	4916	5631	28.03	106.2	6630	518.4	811.4	5.53	79.71	309.8	7402
UB 762 x 267 x 147	168500	4470	5156	30.00	102.4	5455	411.4	647.2	5.40	67.13	162.2	7377
UB 762 x 267 x 173	205300	5387	6198	30.52	115.4	6850	513.7	807.5	5.58	76.83	270.3	9364
UB 762 x 267 x 197	240000	6234	7167	30.94	126.8	8175	610.1	958.6	5.71	85.73	407.3	11290
UB 838 x 292 x 176	246000	5893	6808	33.14	123.7	7799	534.7	841.9	5.90	72.45	226.2	12950
UB 838 x 292 x 194	279200	6641	7640	33.63	130.8	9066	620.1	973.8	6.06	78.95	309.6	15160
UB 838 x 292 x 226	339700	7985	9155	34.31	144.9	11360	773.3	1212	6.27	90.55	516.5	19230
UB 914 x 305 x 201	325300	7204	8351	35.65	144.2	9423	621.4	982	6.07	77.88	297.9	18300
UB 914 x 305 x 224	376400	8269	9535	36.30	153.2	11240	739	1163	6.27	86.08	427.2	22010
UB 914 x 305 x 253	436300	9501	10940	36.76	167.8	13300	870.8	1371	6.42	95.48	630.5	26280
UB 914 x 305 x 289	504200	10880	12570	37.00	189.8	15600	1014	1601	6.51	105.9	933.6	31090
UB 914 x 419 x 343	625800	13730	15480	37.83	191.1	39160	1871	2890	9.46	111.6	1199	75650
UB 914 x 419 x 388	719600	15630	17670	38.16	211.9	45440	2161	3341	9.59	122.8	1741	88690
UB 1016 x 305 x 222	406500	8380	9777	37.95	172.2	9501	633.4	1016	5.80	93.15	403.4	21280
UB 1016 x 305 x 249	481100	9818	11350	38.97	180.7	11750	784	1245	6.09	103.6	584.4	26620
UB 1016 x 305 x 272	553800	11190	12820	39.96	184.6	14000	933.6	1470	6.35	113.6	822.4	32070
UB 1016 x 305 x 314	644700	12890	14860	40.15	212.5	16280	1085	1716	6.38	126.1	1254	37640
UB 1016 x 305 x 349	722300	14330	16570	40.32	235	18460	1222	1940	6.45	136.1	1701	43020
UB 1016 x 305 x 393	807700	15900	18540	40.18	271.3	20500	1353	2168	6.40	147.3	2332	48080
UB 1016 x 305 x 415	853100	16728	19571	40.17	288.6	21710	1428	2298	6.41	153.1	2713	51080
UB 1016 x 305 x 438	909800	17740	20770	40.41	300.9	23360	1532	2464	6.47	160.1	3200	55290
UB 1016 x 305 x 494	1028000	19845	23413	40.42	344.5	26820	1736	2818	6.53	174.1	4433	64010
UB 1016 x 305 x 584	1246100	23600	28039	40.93	403.2	33430	2130	3475	6.70	199.1	7230	81240

工字鋼(等邊) Universal Columns

Profiles are laser fused with full penetration, equivalent to hot rolled. 型材採用激光熔透，等同於熱軋。

- 尺寸: 符合BS 4-1: 1993
- 公差: EN 10034:1993 • 等級: 符合BS EN 10025-2:2004
- Dimension: in accordance with BS 4-1: 1993
- Tolerance: EN 10034:1993 • Grade: according to BS EN 10025-2:2004

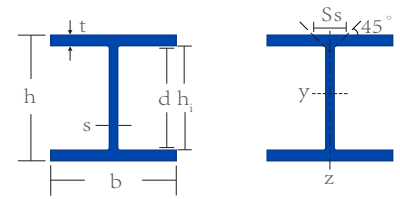

尺寸 Designation	單位重量 Mass per Unit Length	高度 Depth of Section	寬度 Width of Section	腰厚 Web Thickness	腿厚 Flange Thickness	h _i (mm)	d(mm)
	kg/m	h(mm)	b(mm)	s(mm)	t(mm)		
UC 152 x 152 x 23	23.0	152.4	152.2	5.8	6.8	138.8	123.6
UC 152 x 152 x 30	30.0	157.6	152.9	6.5	9.4	138.8	123.6
UC 152 x 152 x 37	37.0	161.8	154.4	8	11.5	138.8	123.6
UC 203 x 203 x 46	46.1	203.2	203.6	7.2	11	181.2	160.8
UC 203 x 203 x 52	52.0	206.2	204.3	7.9	12.5	181.2	160.8
UC 203 x 203 x 60	60.0	209.6	205.8	9.4	14.2	181.2	160.8
UC 203 x 203 x 71	71.0	215.8	206.4	10	17.3	181.2	160.8
UC 203 x 203 x 86	86.1	222.2	209.1	12.7	20.5	181.2	160.8
UC 254 x 254 x 73	73.1	254.1	254.6	8.6	14.2	225.7	200.3
UC 254 x 254 x 89	88.9	260.3	256.3	10.3	17.3	225.7	200.3
UC 254 x 254 x 107	107.1	266.7	258.8	12.8	20.5	225.7	200.3
UC 254 x 254 x 132	132.0	276.3	261.3	15.3	25.3	225.7	200.3
UC 254 x 254 x 167	167.1	289.1	265.2	19.2	31.7	225.7	200.3
UC 305 x 305 x 97	96.9	307.9	305.3	9.9	15.4	277.1	246.7
UC 305 x 305 x 118	117.9	314.5	307.4	12	18.7	277.1	246.7
UC 305 x 305 x 137	136.9	320.5	309.2	13.8	21.7	277.1	246.7
UC 305 x 305 x 158	158.1	327.1	311.2	15.8	25	277.1	246.7
UC 305 x 305 x 198	198.1	339.9	314.5	19.1	31.4	277.1	246.7
UC 305 x 305 x 240	240.0	352.5	318.4	23	37.7	277.1	246.7
UC 305 x 305 x 283	282.9	365.3	322.2	26.8	44.1	277.1	246.7
UC 356 x 368 x 129	129.0	355.6	368.6	10.4	17.5	320.6	290.2
UC 356 x 368 x 153	152.9	362	370.5	12.3	20.7	320.6	290.2
UC 356 x 368 x 177	177.0	368.2	372.6	14.4	23.8	320.6	290.2
UC 356 x 368 x 202	201.9	374.6	374.7	16.5	27	320.6	290.2
UC 356 x 406 x 235	235.1	381	394.8	18.4	30.2	320.6	290.2
UC 356 x 406 x 287	287.1	393.6	399	22.6	36.5	320.6	290.2
UC 356 x 406 x 340	339.9	406.4	403	26.6	42.9	320.6	290.2
UC 356 x 406 x 393	393.0	419	407	30.6	49.2	320.6	290.2
UC 356 x 406 x 467	467.0	436.6	412.2	35.8	58	320.6	290.2

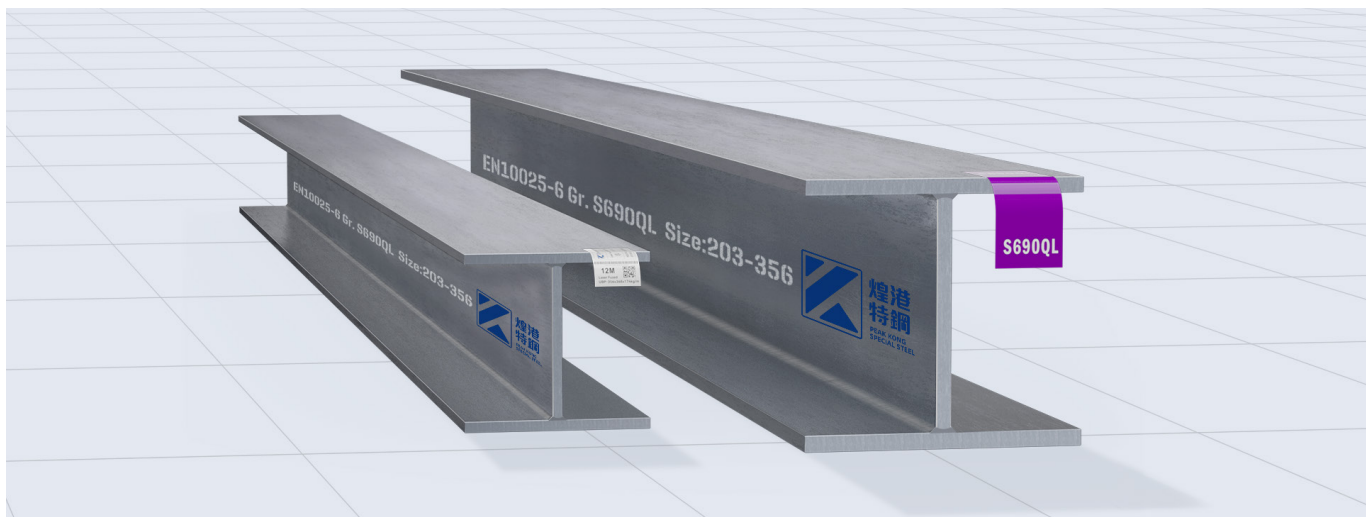

工字鋼 (等邊) Universal Columns

Profiles are laser fused with full penetration, equivalent to hot rolled. 型材採用激光熔透，等同於熱軋。

- 尺寸: 符合BS 4-1: 1993
- 公差: EN 10034:1993 • 等級: 符合BS EN 10025-2:2004
- Dimension: in accordance with BS 4-1: 1993
- Tolerance: EN 10034:1993 • Grade: according to BS EN 10025-2:2004

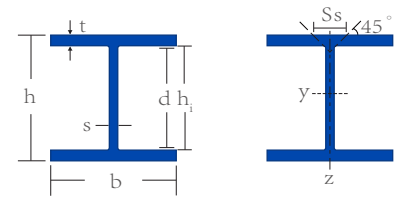

尺寸 Designation	I_y	W_{ely}	W_{ply}	i_y	A_{vz}	I_z	W_{elz}	W_{plz}	i_z	S_s	I_t	I_w
	$mm^4 \times 10^4$	$mm^3 \times 10^3$	$mm^3 \times 10^3$	$mm \times 10$	$mm^2 \times 10^2$	$mm^4 \times 10^4$	$mm^3 \times 10^3$	$mm^3 \times 10^3$	$mm \times 10$	mm	$mm^4 \times 10^4$	$mm^6 \times 10^9$
UC 152 x 152 x 23	1250	164.0	182.0	6.54	9.97	399.9	52.55	80.16	3.70	28.3	4.86	21.18
UC 152 x 152 x 30	1748	221.8	247.7	6.76	11.56	560.5	73.31	111.6	3.83	34.2	10.67	30.75
UC 152 x 152 x 37	2210	273.2	308.8	6.85	14.27	706.2	91.48	139.6	3.87	39.9	19.49	39.84
UC 203 x 203 x 46	4568	449.6	497.4	8.82	16.98	1548	152.1	230.9	5.13	41.2	22.34	142.9
UC 203 x 203 x 52	5259	510.1	567.4	8.91	18.75	1778	174.0	264.2	5.18	44.9	31.97	166.6
UC 203 x 203 x 60	6125	584.4	656.1	8.96	22.16	2065	200.6	305.3	5.20	49.8	47.78	196.9
UC 203 x 203 x 71	7618	706.0	798.8	9.18	24.27	2537	245.9	373.7	5.30	56.6	80.63	249.7
UC 203 x 203 x 86	9449	850.5	976.7	9.28	30.69	3127	299.1	456.2	5.34	65.7	138.3	317.7
UC 254 x 254 x 73	11410	897.9	992.1	11.07	25.62	3908	307.0	465.4	6.48	51.9	57.74	562.0
UC 254 x 254 x 89	14270	1096	1224	11.22	30.81	4857	379.0	575.3	6.55	59.8	102.7	716.6
UC 254 x 254 x 107	17510	1313	1484	11.33	38.11	5928	458.1	697.0	6.59	68.7	173.9	897.5
UC 254 x 254 x 132	22530	1631	1869	11.58	46.21	7531	576.4	878.4	6.69	80.8	321.5	1185
UC 254 x 254 x 167	30000	2075	2424	11.87	58.86	9870	744.3	1137	6.81	97.5	633.8	1632
UC 305 x 305 x 97	22250	1445	1592	13.42	35.62	7308	478.7	726.1	7.69	58.5	91.80	1562
UC 305 x 305 x 118	27670	1760	1958	13.57	43.16	9059	589.4	895.4	7.77	67.2	162.3	1980
UC 305 x 305 x 137	32810	2048	2297	13.72	49.81	10700	692.1	1053	7.83	75.0	251.1	2386
UC 305 x 305 x 158	38750	2369	2680	13.87	57.32	12570	807.8	1230	7.90	83.6	381.6	2865
UC 305 x 305 x 198	50900	2995	3440	14.20	70.45	16300	1037	1581	8.04	99.7	741.2	3873
UC 305 x 305 x 240	64200	3643	4247	14.49	85.85	20310	1276	1951	8.15	116.2	1287	5025
UC 305 x 305 x 283	78870	4318	5105	14.79	101.5	24630	1529	2342	8.27	132.8	2062	6341
UC 356 x 368 x 129	40250	2264	2479	15.65	42.47	14610	792.8	1119	9.43	63.2	152.7	4174
UC 356 x 368 x 153	48590	2684	2965	15.79	50.26	17750	947.5	1435	9.49	71.5	251.2	5110
UC 356 x 368 x 177	57120	3103	3455	15.91	58.81	20530	1102	1671	9.54	79.8	383.5	6084
UC 356 x 368 x 202	66260	3538	3972	16.05	67.55	23690	1264	1920	9.60	88.3	561.4	7151
UC 356 x 406 x 235	79080	4151	4687	16.25	75.71	30990	1570	2383	10.20	96.6	817.7	9529
UC 356 x 406 x 287	99880	5075	5812	16.53	93.78	38680	1939	2949	10.28	113.4	1455	12320
UC 356 x 406 x 340	122500	6031	6999	16.82	111.7	46850	2325	3544	10.40	130.2	2370	15460
UC 356 x 406 x 393	146600	6998	8222	17.11	130.1	55370	2721	4154	10.52	146.8	3592	18900
UC 356 x 406 x 467	183000	8383	10000	17.54	155.2	67830	3291	5034	10.68	169.6	5896	24260

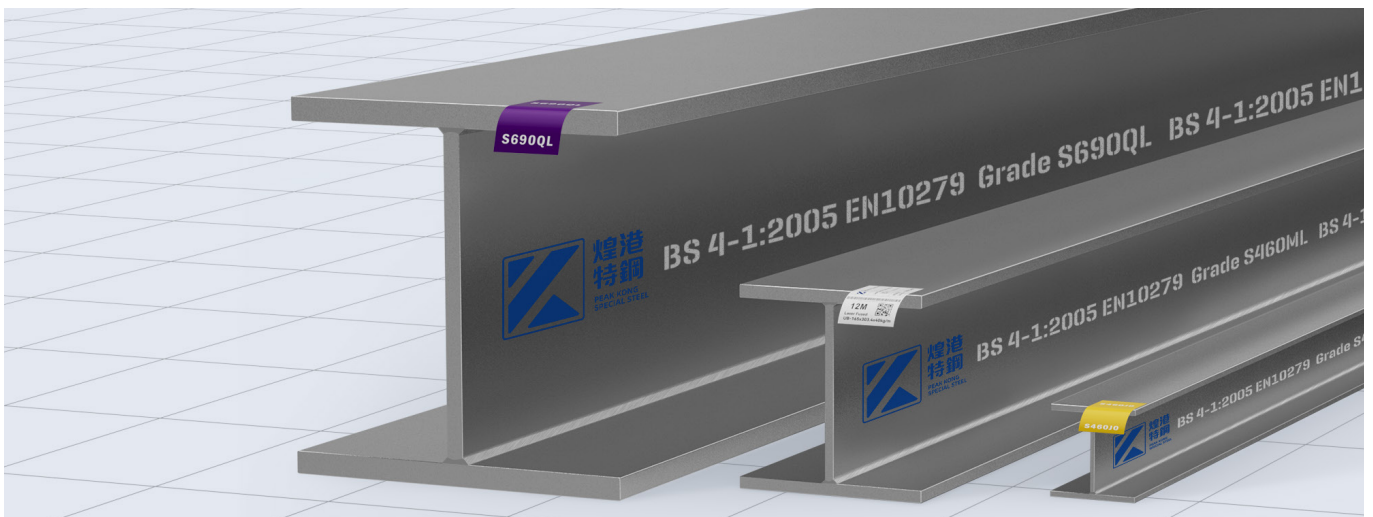

寬翼緣通用承載樁 Universal Bearing Piles With Wide Flanges

Profiles are laser fused with full penetration, equivalent to hot rolled. 型材採用激光熔透，等同於熱軋。

- 尺寸：符合BS 4-1: 1993
- 公差：EN 10034:1993 • 等級：符合BS EN 10025-2:2004
- Dimension: in accordance with BS 4-1: 1993
- Tolerance: EN 10034:1993 • Grade: according to BS EN 10025-2:2004

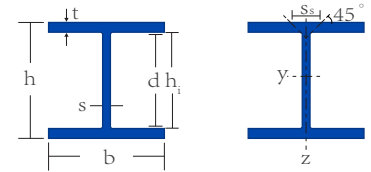

尺寸 Designation	單位重量 Mass per Unit Length	高度 Depth of Section	寬度 Width of Section	腰厚 Web Thickness	腿厚 Flange Thickness	h ₁ (mm)	d(mm)
	kg/m	h(mm)	b(mm)	s(mm)	t(mm)		
UBP 203 x 203 x 45	44.9	200.2	205.9	9.5	9.5	181.2	160.8
UBP 203 x 203 x 54	53.9	204	207.7	11.3	11.4	181.2	160.8
UBP 254 x 254 x 63	63.0	247.1	256.6	10.6	10.7	225.7	200.3
UBP 254 x 254 x 71	71.0	249.7	258	12	12	225.7	200.3
UBP 254 x 254 x 85	85.1	254.3	260.4	14.4	14.3	225.7	200.3
UBP 305 x 305 x 79	78.9	299.3	306.4	11	11.1	277.1	246.7
UBP 305 x 305 x 88	88.0	301.7	307.8	12.4	12.3	277.1	246.7
UBP 305 x 305 x 95	94.9	303.7	308.7	13.3	13.3	277.1	246.7
UBP 305 x 305 x 110	110.0	307.9	310.7	15.3	15.4	277.1	246.7
UBP 305 x 305 x 126	126.0	312.3	312.9	17.5	17.6	277.1	246.7
UBP 305 x 305 x 149	149.0	318.5	316	20.6	20.7	277.1	246.7
UBP 305 x 305 x 186	186.0	328.3	320.9	25.5	25.6	277.1	246.7
UBP 305 x 305 x 223	223.0	337.9	325.7	30.3	30.4	277.1	246.7
UBP 356 x 368 x 109	109.0	346.4	371	12.8	12.9	320.6	290.2
UBP 356 x 368 x 133	133.0	352	373.8	15.6	15.7	320.6	290.2
UBP 356 x 368 x 152	152.0	356.4	376	17.8	17.9	320.6	290.2
UBP 356 x 368 x 174	174.0	361.4	378.5	20.3	20.4	320.6	290.2

尺寸 Designation	I _y	W _{el,y}	W _{pl,y}	i _y	A _{vz}	I _z	W _{el,z}	W _{pl,z}	i _z	S _s	I _t	I _w
	mm ⁴ x 10 ⁴	mm ³ x 10 ³	mm ³ x 10 ³	mm x 10	mm ² x 10 ²	mm ⁴ x 10 ⁴	mm ³ x 10 ³	mm ³ x 10 ³	mm x 10	mm	mm ⁴ x 10 ⁴	mm ⁶ x 10 ⁹
UBP 203 x 203 x 45	4100	409.6	458.9	8.46	20.95	1384	134.4	206.1	4.92	40.45	20.80	125.7
UBP 203 x 203 x 54	5027	492.8	556.7	8.55	24.98	1705	164.2	252.4	4.98	46.05	34.97	157.9
UBP 254 x 254 x 63	8860	717.2	799.3	10.51	29.16	3016	235.1	359.7	6.13	46.88	37.20	421.0
UBP 254 x 254 x 71	10070	806.7	904.0	10.56	32.96	3439	266.6	408.7	6.17	50.88	52.27	485.2
UBP 254 x 254 x 85	12280	966.1	1092	10.65	39.58	4215	323.8	497.9	6.24	57.88	87.82	606.0
UBP 305 x 305 x 79	16440	1099	1218	12.79	37.06	5326	347.7	531.2	7.28	51.01	51.37	1105
UBP 305 x 305 x 88	18420	1221	1360	12.82	41.61	5984	388.9	595.2	7.31	54.81	70.05	1252
UBP 305 x 305 x 95	20040	1320	1474	12.87	44.65	6529	423.0	648.0	7.35	57.71	86.69	1375
UBP 305 x 305 x 110	23560	1531	1720	12.97	51.42	7709	496.2	761.7	7.42	63.91	131.4	1647
UBP 305 x 305 x 126	27410	1755	1986	13.06	58.91	9002	575.4	885.2	7.49	70.51	194.3	1951
UBP 305 x 305 x 149	33070	2076	2370	13.20	69.62	10910	690.5	1066	7.58	79.81	314.2	2414
UBP 305 x 305 x 186	42610	2596	3003	13.41	86.95	14140	881.5	1366	7.73	94.51	593.7	3230
UBP 305 x 305 x 223	52700	3119	3653	13.62	104.40	17580	1079	1680	7.87	108.9	998.4	4138
UBP 356 x 368 x 109	30630	1769	1956	14.86	48.59	10990	592.3	902.9	8.90	56.41	90.73	3053
UBP 356 x 368 x 133	37980	2158	2404	14.98	59.22	13680	731.9	1119	8.99	64.81	160.7	3864
UBP 356 x 368 x 152	43970	2468	2767	15.07	67.68	15880	844.5	1293	9.05	71.41	236.4	4543
UBP 356 x 368 x 174	51010	2823	3186	15.18	77.41	18460	975.6	1497	9.13	78.91	348.5	5360

托梁 Joists

Profiles are laser fused with full penetration, equivalent to hot rolled. 型材採用激光熔透，等同於熱軋。

- 尺寸：符合BS 4-1: 1993
- 公差：EN 10024:1993 • 等級：符合BS EN 10025-2:2004
- Dimension: in accordance with BS 4-1: 1993
- Tolerance: EN 10034:1993 • Grade: according to BS EN 10025-2:2004

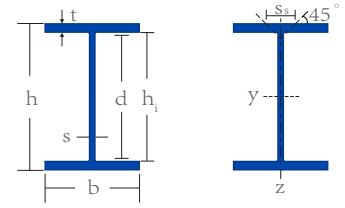

尺寸 Designation	單位重量 Mass per Unit Length	高度 Depth of Section	寬度 Width of Section	腰厚 Web Thickness	腿厚 Flange Thickness
	kg/m	h(mm)	b(mm)	s(mm)	t(mm)
J 76 x 76 x 13	12.6	76.2	76.2	5.1	8.4
J 76 x 76 x 15	14.8	76.2	80	8.9	8.4
J 89 x 89 x 19	19.1	88.9	88.9	9.5	9.9
J 102 x 44 x 7	7.4	101.6	44.5	4.3	6.1
J 102 x 102 x 23	22.6	101.6	101.6	9.5	10.3
J 114 x 114 x 27	26.6	114.3	114.3	9.5	10.7
J 127 x 76 x 16	16.4	127	76.2	5.6	9.6
J 127 x 114 x 27	26.5	127	114.3	7.4	11.4
J 127 x 114 x 29	28.9	127	114.3	10.2	11.5
J 152 x 127 x 37	36.8	152.4	127	10.4	13.2
J 203 x 152 x 52	51.8	203.2	152.4	8.9	16.5
J 254 x 114 x 37	36.8	254	114.3	7.6	12.8
J 254 x 203 x 82	81.6	254	203.2	10.2	19.9

尺寸 Designation	I_y	$W_{el,y}$	$W_{pl,y}$	i_y	A_{vz}	I_z	$W_{el,z}$	$W_{pl,z}$	i_z	S_s	I_t	I_w
	mm ⁴ x 10 ⁴	mm ³ x 10 ³	mm ³ x 10 ³	mm x 10	mm ² x 10 ²	mm ⁴ x 10 ⁴	mm ³ x 10 ³	mm ³ x 10 ³	mm x 10	mm	mm ⁴ x 10 ⁴	mm ⁶ x 10 ⁹
J 76 x 76 x 13	158	41.4	48.1	3.13	5.65	52.5	13.8	22.7	1.81	34.5	4.39	0.62
J 76 x 76 x 15	171	44.8	53.1	3.01	8.12	60.8	15.2	25.6	1.80	38.1	7.73	0.71
J 89 x 89 x 19	303	68.1	80.8	3.52	10.43	98.9	22.2	37.4	2.01	43.7	12.7	1.58
J 102 x 44 x 7	152	29.9	35.0	4.02	5.24	7.82	3.52	6.04	0.91	25.0	1.29	0.18
J 102 x 102 x 23	479	94.3	111	4.08	11.71	152	29.9	50.1	2.30	45.2	14.9	3.23
J 114 x 114 x 27	729	128	148	4.64	14.68	218	38.1	65.0	2.54	50.6	21.2	6.06
J 127 x 76 x 16	568	89.5	103	5.22	8.95	61.5	16.1	26.7	1.72	37.3	6.44	2.17
J 127 x 114 x 27	940	148	169	5.27	11.46	240	42.0	69.0	2.67	45.1	15.8	8.13
J 127 x 114 x 29	968	152	177	5.13	14.59	243	42.6	70.8	2.57	47.8	20.6	8.21
J 152 x 127 x 37	1802	237	274	6.20	19.20	382	60.1	100	2.85	55.5	33.6	18.9
J 203 x 152 x 52	4772	470	534	8.51	23.41	831	109	179	3.55	64.1	60.2	73.8
J 254 x 114 x 37	5042	397	454	10.36	22.54	273	47.8	80.0	2.41	50.5	23.9	40.6
J 254 x 203 x 82	12010	946	1066	10.75	35.84	2326	229	378	4.73	80.4	142	326



角鐵(等邊) Equal Angles

Profiles are laser fused with full penetration, equivalent to hot rolled. 型材採用激光熔透，等同於熱軋。

- 尺寸: 符合BS EN 10056-1:1999
- 公差: BS EN 10056-2:1993 • 等級: 符合BS EN 10025-2:2004
- Dimension: in accordance with BS EN 10056-1:1999
- Tolerance: BS EN 10056-2:1993 • Grade: according to BS EN 10025-2:2004

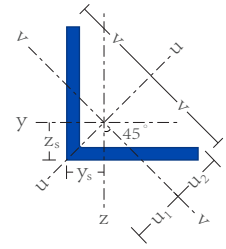
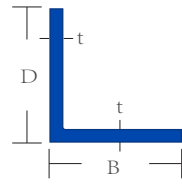

尺寸 Size	單位重量 Mass per Unit Length	$Z_s=Y_s$	v	u_1	u_2
D x B x t (mm)	kg/m	mm	mm	mm	mm
L 30 x 30 x 3	1.36	8.35	21.21	11.81	10.49
L 30 x 30 x 4	1.78	8.78	21.21	12.42	10.58
L 30 x 30 x 5	2.18	9.18	21.21	12.99	10.73
L 30 x 30 x 6	2.57	9.56	21.21	13.52	10.90
L 35 x 35 x 4	2.09	10.03	24.75	14.18	12.36
L 35 x 35 x 5	2.57	10.43	24.75	14.75	12.50
L 40 x 40 x 3	1.84	10.84	28.28	15.33	14.04
L 40 x 40 x 4	2.42	11.20	28.28	15.83	14.04
L 40 x 40 x 5	2.97	11.62	28.28	16.43	14.14
L 40 x 40 x 6	3.52	12.02	28.28	17.00	14.29
L 45 x 45 x 3	2.09	11.84	31.82	16.74	15.75
L 45 x 45 x 4	2.74	12.35	31.82	17.46	15.74
L 45 x 45 x 4.5	3.06	12.60	31.82	17.80	15.80
L 45 x 45 x 5	3.38	12.79	31.82	18.09	15.81
L 50 x 50 x 3	2.33	13.08	35.36	18.49	17.53
L 50 x 50 x 4	3.06	13.59	35.36	19.21	17.52
L 50 x 50 x 5	3.77	14.04	35.36	19.85	17.59
L 50 x 50 x 6	4.47	14.45	35.36	20.44	17.71
L 50 x 50 x 7	5.15	14.85	35.36	21.01	17.85
L 50 x 50 x 8	5.82	15.24	35.36	21.55	18.01
L 60 x 60 x 5	4.57	16.44	42.43	23.24	21.06
L 60 x 60 x 6	5.42	16.88	42.43	23.87	21.15
L 60 x 60 x 7	6.26	17.29	42.43	24.45	21.27
L 60 x 60 x 8	7.09	17.69	42.43	25.02	21.41
L 60 x 60 x 10	8.69	18.46	42.43	26.10	21.74
L 65 x 65 x 6	5.91	18.04	45.96	25.51	22.83
L 65 x 65 x 7	6.83	18.47	45.96	26.12	22.93
L 65 x 65 x 8	7.73	18.88	45.96	26.70	23.06
L 65 x 65 x 9	8.62	19.28	45.96	27.26	23.20
L 65 x 65 x 10	9.49	19.66	45.96	27.81	23.36
L 70 x 70 x 5	5.37	18.82	49.50	26.62	24.55
L 70 x 70 x 6	6.38	19.28	49.50	27.27	24.61
L 70 x 70 x 7	7.38	19.71	49.50	27.88	24.70
L 70 x 70 x 8	8.37	20.06	49.50	28.37	24.72
L 70 x 70 x 9	9.32	20.53	49.50	29.03	24.97
L 70 x 70 x 10	10.3	20.91	49.50	29.58	25.13
L 75 x 75 x 5	5.76	20.06	53.03	28.37	26.33
L 75 x 75 x 6	6.85	20.53	53.03	29.03	26.38
L 75 x 75 x 7	7.93	20.96	53.03	29.64	26.48
L 75 x 75 x 8	8.99	21.37	53.03	30.23	26.60
L 75 x 75 x 9	10.0	21.77	53.03	30.79	26.74
L 75 x 75 x 10	11.1	22.16	53.03	31.35	26.89
L 80 x 80 x 6	7.34	21.67	56.57	30.65	28.09
L 80 x 80 x 7	8.49	22.12	56.57	31.29	28.16
L 80 x 80 x 8	9.63	22.55	56.57	31.89	28.26
L 80 x 80 x 9	10.8	22.96	56.57	32.47	28.39
L 80 x 80 x 10	11.9	23.36	56.57	33.04	28.53

角鐵(等邊) (續) Equal Angles (Continued)

Profiles are laser fused with full penetration, equivalent to hot rolled. 型材採用激光熔透，等同於熱軋。

- 尺寸: 符合BS EN 10056-1:1999
- 公差: BS EN 10056-2:1993 • 等級: 符合BS EN 10025-2:2004
- Dimension: in accordance with BS EN 10056-1:1999
- Tolerance: BS EN 10056-2:1993 • Grade: according to BS EN 10025-2:2004

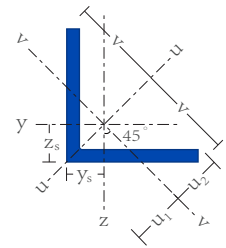
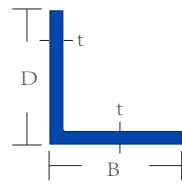

尺寸 Size	單位重量 Mass per Unit Length	$Z_s=Y_s$	v	U_1	U_2
D x B x t (mm)	kg/m	mm	mm	mm	mm
L 90 x 90 x 6	8.30	24.16	63.64	34.17	31.64
L 90 x 90 x 7	9.61	24.52	63.64	34.68	31.63
L 90 x 90 x 8	10.9	24.96	63.64	35.31	31.71
L 90 x 90 x 9	12.2	25.39	63.64	35.90	31.82
L 90 x 90 x 10	13.4	25.80	63.64	36.48	31.95
L 100 x 100 x 6	9.26	26.42	70.71	37.36	35.10
L 100 x 100 x 7	10.7	26.91	70.71	38.06	35.12
L 100 x 100 x 8	12.2	27.37	70.71	38.70	35.18
L 100 x 100 x 9	13.6	27.80	70.71	39.32	35.27
L 100 x 100 x 10	15.0	28.22	70.71	39.92	35.38
L 100 x 100 x 12	17.8	29.03	70.71	41.06	35.65
L 110 x 110 x 6	10.2	28.91	77.78	40.88	38.86
L 110 x 110 x 7	11.8	29.40	77.78	41.58	38.67
L 110 x 110 x 8	13.4	29.86	77.78	42.23	38.73
L 110 x 110 x 9	15.0	30.30	77.78	42.85	38.81
L 110 x 110 x 10	16.6	30.64	77.78	43.34	38.82
L 110 x 110 x 11	18.2	31.06	77.78	43.93	38.94
L 110 x 110 x 12	19.7	31.47	77.78	44.50	39.07
L 120 x 120 x 7	12.9	31.78	84.85	44.94	42.17
L 120 x 120 x 8	14.7	32.25	84.85	45.61	42.21
L 120 x 120 x 9	16.5	32.70	84.85	46.25	42.27
L 120 x 120 x 10	18.2	33.14	84.85	46.86	42.37
L 120 x 120 x 11	19.9	33.56	84.85	47.46	42.48
L 120 x 120 x 12	21.6	33.97	84.85	48.03	42.61
L 120 x 120 x 13	23.3	34.37	84.85	48.60	42.75
L 120 x 120 x 14	25.0	34.76	84.85	49.16	42.90
L 120 x 120 x 15	26.6	35.15	84.85	49.71	43.06
L 120 x 120 x 16	28.3	35.53	84.85	50.25	43.22
L 125 x 125 x 8	15.20	34.20	88.39	48.36	45.27
L 125 x 125 x 9	17.14	34.04	88.39	48.14	44.13
L 125 x 125 x 10	18.96	34.46	88.39	48.74	44.24
L 125 x 125 x 12	22.11	35.28	88.39	49.89	44.50
L 125 x 125 x 15	27.67	36.75	88.39	51.97	46.61
L 130 x 130 x 8	16.0	34.64	91.92	48.98	45.70
L 130 x 130 x 9	17.9	35.10	91.92	49.64	45.75
L 130 x 130 x 10	19.8	35.55	91.92	50.27	45.83
L 130 x 130 x 11	21.7	35.98	91.92	50.88	45.93
L 130 x 130 x 12	23.6	36.39	91.92	51.47	46.04
L 130 x 130 x 13	25.4	36.80	91.92	52.05	46.17
L 130 x 130 x 14	27.2	37.20	91.92	52.61	46.31
L 130 x 130 x 15	29.0	37.60	91.92	53.17	46.46
L 130 x 130 x 16	30.8	37.99	91.92	53.72	46.62
L 140 x 140 x 9	19.3	37.49	98.99	53.02	49.23
L 140 x 140 x 10	21.4	37.95	98.99	53.67	49.29
L 140 x 140 x 11	23.4	38.39	98.99	54.29	49.38
L 140 x 140 x 12	25.4	38.81	98.99	54.89	49.48
L 140 x 140 x 13	27.5	39.23	98.99	55.48	49.60

角鐵(等邊) (續) Equal Angles (Continued)

Profiles are laser fused with full penetration, equivalent to hot rolled. 型材採用激光熔透，等同於熱軋。

- 尺寸: 符合BS EN 10056-1:1999
- 公差: BS EN 10056-2:1993 • 等級: 符合BS EN 10025-2:2004
- Dimension: in accordance with BS EN 10056-1:1999
- Tolerance: BS EN 10056-2:1993 • Grade: according to BS EN 10025-2:2004

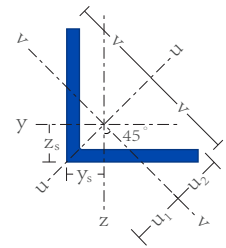
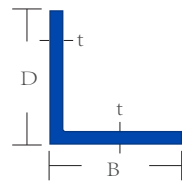

尺寸 Size	單位重量 Mass per Unit Length	$Z_s=Y_s$	v	u_1	u_2
D x B x t (mm)	kg/m	mm	mm	mm	mm
L 140 x 140 x 14	29.4	39.64	98.99	56.06	49.73
L 140 x 140 x 15	31.4	40.04	98.99	56.62	49.87
L 140 x 140 x 16	33.3	40.43	98.99	57.18	50.02
L 150 x 150 x 8	18.34	40.45	106.07	57.21	54.10
L 150 x 150 x 9	20.68	40.28	106.07	56.96	52.96
L 150 x 150 x 10	23.0	40.34	106.07	57.05	52.77
L 150 x 150 x 12	27.3	41.23	106.07	58.31	52.93
L 150 x 150 x 13	29.5	41.65	106.07	58.90	53.04
L 150 x 150 x 14	31.6	42.07	106.07	59.49	53.16
L 150 x 150 x 15	33.8	42.47	106.07	60.07	53.29
L 150 x 150 x 16	35.9	42.87	106.07	60.63	53.43
L 150 x 150 x 18	40.1	43.66	106.07	61.74	53.74
L 150 x 150 x 20	44.2	44.43	106.07	62.83	54.07
L 160 x 160 x 14	33.9	44.50	113.14	62.90	56.60
L 160 x 160 x 15	36.2	44.90	113.14	63.50	56.72
L 160 x 160 x 16	38.4	45.31	113.14	64.08	56.85
L 160 x 160 x 17	40.7	45.70	113.14	64.60	57.00
L 160 x 160 x 18	42.9	46.10	113.14	65.20	57.14
L 160 x 160 x 20	47.3	46.88	113.14	66.30	57.46
L 175 x 175 x 12	31.84	48.18	123.74	68.14	63.67
L 175 x 175 x 15	39.45	49.28	123.74	69.69	64.24
L 180 x 180 x 13	35.7	48.97	127.28	69.26	63.49
L 180 x 180 x 14	38.3	49.40	127.28	69.90	63.60
L 180 x 180 x 15	40.9	49.82	127.28	70.46	63.70
L 180 x 180 x 16	43.5	50.24	127.28	71.05	63.82
L 180 x 180 x 17	46.0	50.60	127.28	71.60	64.00
L 180 x 180 x 18	48.6	51.04	127.28	72.19	64.09
L 180 x 180 x 19	51.1	51.40	127.28	72.70	64.20
L 180 x 180 x 20	53.7	51.83	127.28	73.30	64.39
L 200 x 200 x 12	36.55	54.44	141.42	76.99	72.50
L 200 x 200 x 13	39.8	53.96	141.42	76.31	70.57
L 200 x 200 x 15	45.6	54.82	141.42	77.52	70.78
L 200 x 200 x 16	48.5	55.23	141.42	78.11	70.90
L 200 x 200 x 17	51.4	55.60	141.42	78.70	71.00
L 200 x 200 x 18	54.3	56.04	141.42	79.26	71.17
L 200 x 200 x 19	57.1	56.40	141.42	79.80	71.30
L 200 x 200 x 20	59.9	56.83	141.42	80.38	71.46
L 200 x 200 x 21	62.8	57.20	141.42	80.90	71.60
L 200 x 200 x 22	65.6	57.60	141.42	81.50	71.80
L 200 x 200 x 23	68.3	58.00	141.42	82.00	71.90
L 200 x 200 x 24	71.1	58.40	141.42	82.60	72.10
L 200 x 200 x 25	73.9	58.80	141.42	83.10	72.30
L 203 x 203 x 19	57.98	57.60	143.50	81.50	73.80
L 203 x 203 x 22.2	66.72	58.80	143.50	83.20	74.40
L 250 x 250 x 13	49.97	66.44	176.78	93.96	88.28
L 250 x 250 x 15	57.38	67.30	176.78	95.18	88.47
L 250 x 250 x 18	68.37	68.54	176.78	96.93	88.85

角鐵(等邊) (續) Equal Angles (Continued)

Profiles are laser fused with full penetration, equivalent to hot rolled. 型材採用激光熔透，等同於熱軋。

- 尺寸: 符合BS EN 10056-1:1999
- 公差: BS EN 10056-2:1993 • 等級: 符合BS EN 10025-2:2004
- Dimension: in accordance with BS EN 10056-1:1999
- Tolerance: BS EN 10056-2:1993 • Grade: according to BS EN 10025-2:2004

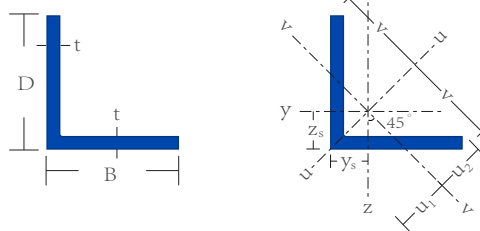

尺寸 Size	單位重量 Mass per Unit Length	$Z_s=Y_s$	v	u_1	u_2
D x B x t (mm)	kg/m	mm	mm	mm	mm
L 250 x 250 x 20	75.3	69.34	176.78	98.06	89.13
L 250 x 250 x 21	78.9	69.70	176.78	98.60	89.30
L 250 x 250 x 22	82.5	70.10	176.78	99.20	89.40
L 250 x 250 x 23	86.1	70.50	176.78	99.70	89.60
L 250 x 250 x 24	89.2	70.90	176.78	100.30	89.80
L 250 x 250 x 25	93.2	71.30	176.78	100.80	89.90
L 300 x 300 x 13	60.18	78.93	212.13	111.63	105.97
L 300 x 300 x 15	69.16	79.80	212.13	112.85	106.16
L 300 x 300 x 16	73.63	80.22	212.13	113.44	106.28
L 300 x 300 x 18	82.51	81.04	212.13	114.60	106.53
L 300 x 300 x 20	91.33	81.84	212.13	115.74	106.81

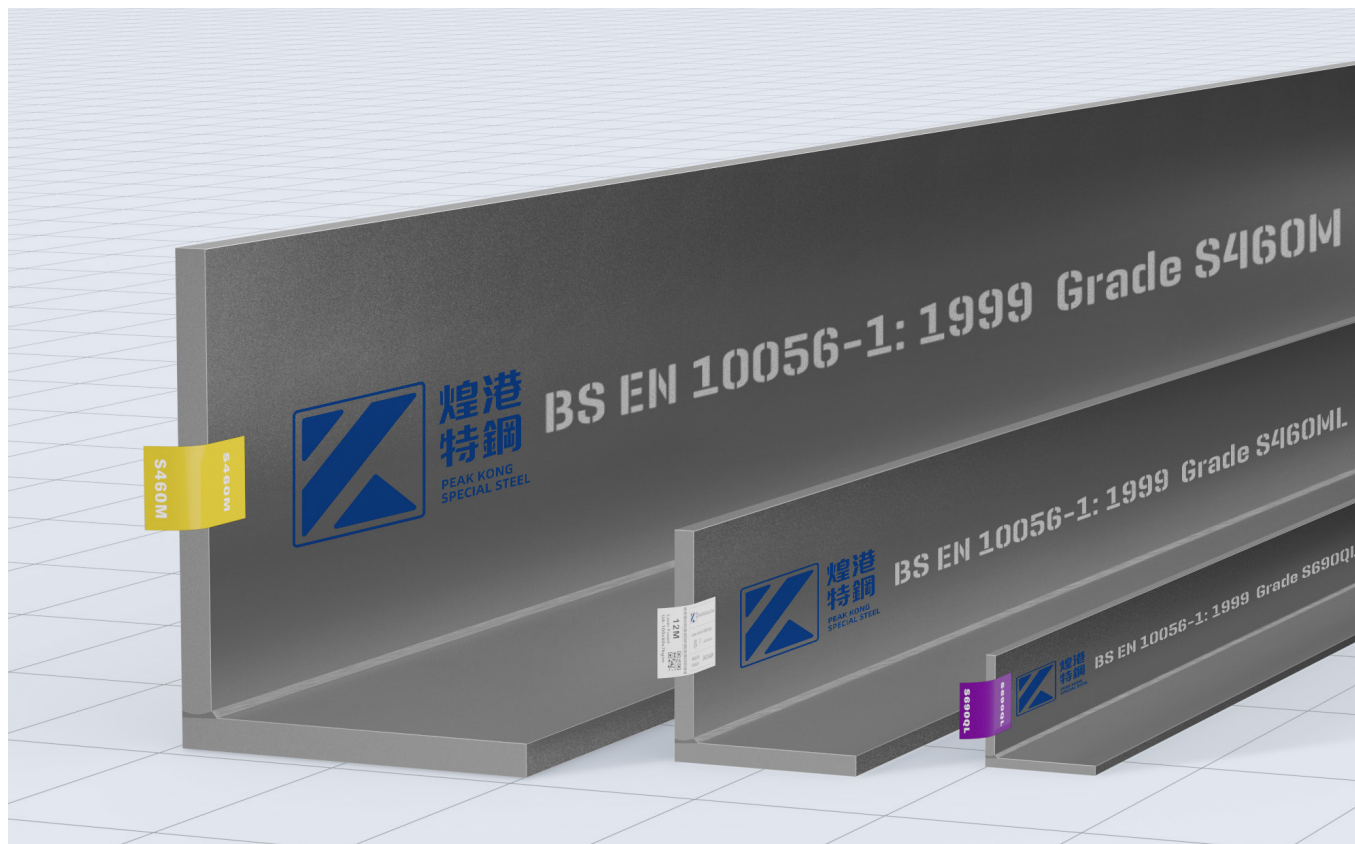

角鐵(不等邊) Unequal Angles

Profiles are laser fused with full penetration, equivalent to hot rolled. 型材採用激光熔透，等同於熱軋。

- 尺寸: 符合BS EN 10056-1:1999
- 公差: BS EN 10056-2:1993 • 等級: 符合BS EN 10025-2:2004
- Dimension: in accordance with BS EN 10056-1:1999
- Tolerance: BS EN 10056-2:1993 • Grade: according to BS EN 10025-2:2004

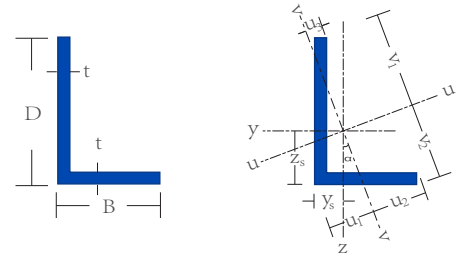

尺寸 Size	單位重量 Mass per Unit Length	y_s	z_s	v_1	v_2	u_1	u_2	u_3
D x B x t (mm)	kg/m	mm	mm	mm	mm	mm	mm	mm
L 30 x 20 x 3	1.12	4.97	9.78	20.55	14.87	8.39	10.42	5.29
L 30 x 20 x 4	1.46	5.38	10.24	20.31	15.09	8.92	10.30	5.99
L 40 x 20 x 3	1.36	4.37	14.06	26.22	17.48	7.70	11.89	4.51
L 40 x 20 x 4	1.77	4.76	14.42	25.97	17.67	8.10	11.64	4.79
L 40 x 20 x 5	2.17	5.17	14.89	25.62	17.98	8.55	11.44	5.16
L 40 x 30 x 3	1.62	7.34	12.21	27.92	21.55	12.28	14.62	8.56
L 40 x 30 x 4	2.10	7.71	12.57	27.81	21.64	12.75	14.49	8.68
L 40 x 30 x 5	2.60	8.12	13.01	27.63	21.80	13.30	14.44	8.93
L 45 x 30 x 3	1.73	6.80	13.94	31.25	21.89	11.70	16.00	7.53
L 45 x 30 x 4	2.27	7.26	14.49	30.92	22.23	12.36	15.72	7.85
L 45 x 30 x 5	2.80	7.69	14.97	30.65	22.48	12.92	15.57	8.15
L 50 x 30 x 3	1.85	6.46	16.02	34.21	22.88	11.38	16.98	6.97
L 50 x 30 x 4	2.43	6.92	16.58	33.83	23.28	12.02	16.66	7.33
L 50 x 30 x 5	3.00	7.35	17.07	33.51	23.57	12.56	16.46	7.66
L 50 x 30 x 6	3.52	7.77	17.60	33.16	23.90	13.10	16.39	8.11
L 50 x 40 x 3	2.09	9.58	14.38	35.35	28.20	15.70	18.61	11.77
L 50 x 40 x 4	2.75	10.06	14.91	35.14	28.43	16.40	18.41	11.97
L 50 x 40 x 5	3.40	10.50	15.38	34.98	28.58	17.01	18.33	12.19
L 60 x 30 x 5	3.40	6.75	21.28	39.20	26.31	11.75	17.70	6.91
L 60 x 30 x 6	4.03	7.17	21.76	38.83	26.65	12.23	17.48	7.28
L 60 x 30 x 7	4.62	7.57	22.22	38.50	26.94	12.66	17.30	7.64
L 60 x 40 x 5	3.80	9.61	19.33	41.17	29.74	16.45	21.03	10.54
L 60 x 40 x 6	4.51	10.03	19.79	40.92	29.97	17.00	20.89	10.84
L 65 x 50 x 5	4.40	12.34	19.60	45.55	35.68	20.42	23.85	14.47
L 65 x 50 x 6	5.20	12.78	20.08	45.36	35.87	21.04	23.74	14.71
L 65 x 50 x 7	6.05	13.19	20.52	45.19	36.03	21.61	23.68	14.95
L 65 x 50 x 8	6.79	13.59	20.94	45.04	36.16	22.15	23.67	15.20
L 65 x 50 x 9	7.60	13.98	21.35	44.90	36.28	22.66	23.69	15.46
L 70 x 50 x 6	5.47	12.35	22.10	48.43	36.45	20.84	25.15	13.91
L 70 x 50 x 7	6.28	12.77	22.55	48.22	36.64	21.39	25.06	14.19
L 70 x 50 x 8	7.10	13.17	22.98	48.03	36.81	21.92	25.01	14.46
L 70 x 50 x 9	7.91	13.56	23.39	47.85	36.95	22.41	24.99	14.74
L 75 x 50 x 6	5.71	11.96	24.16	51.42	37.25	20.55	26.32	13.23
L 75 x 50 x 7	6.55	12.38	24.62	51.18	37.47	21.09	26.20	13.53
L 75 x 50 x 8	7.42	12.78	25.05	50.95	37.67	21.60	26.11	13.83
L 75 x 50 x 9	8.27	13.17	25.47	50.74	37.84	22.08	26.06	14.13
L 75 x 55 x 6	5.91	13.55	23.32	52.10	39.81	22.78	27.21	15.57
L 75 x 55 x 7	6.61	13.97	23.77	51.91	39.99	23.35	27.13	15.84
L 75 x 55 x 8	7.73	14.37	24.20	51.73	40.15	23.88	27.09	16.11
L 75 x 55 x 9	8.71	14.77	24.61	51.56	40.29	24.39	27.07	16.37
L 80 x 40 x 6	5.47	8.74	28.13	52.43	34.95	15.39	23.78	9.03
L 80 x 40 x 8	7.17	9.57	29.10	51.70	35.62	16.35	23.33	9.77
L 80 x 65 x 6	6.67	16.35	23.66	56.26	46.17	26.54	29.52	19.77
L 80 x 65 x 8	8.77	17.21	24.56	55.98	46.44	27.73	29.44	20.20
L 80 x 65 x 10	10.70	18.80	25.38	55.74	46.65	28.82	29.49	20.66

角鐵(不等邊) (續) Unequal Angles (Continued)

Profiles are laser fused with full penetration, equivalent to hot rolled. 型材採用激光熔透，等同於熱軋。

- 尺寸: 符合BS EN 10056-1:1999
- 公差: BS EN 10056-2:1993 • 等級: 符合BS EN 10025-2:2004
- Dimension: in accordance with BS EN 10056-1:1999
- Tolerance: BS EN 10056-2:1993 • Grade: according to BS EN 10025-2:2004

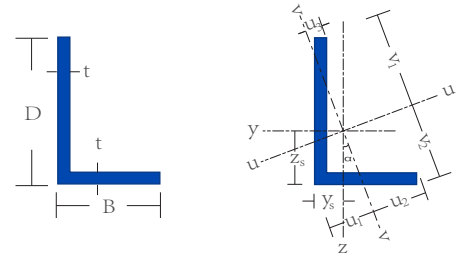

尺寸 Size	單位重量 Mass per Unit Length	y_s	z_s	v_1	v_2	u_1	u_2	u_3
D x B x t (mm)	kg/m	mm	mm	mm	mm	mm	mm	mm
L 90 x 60 x 6	6.91	13.82	28.38	62.06	44.34	23.92	31.83	15.48
L 90 x 60 x 8	9.09	14.68	29.34	61.52	44.86	25.08	31.48	16.09
L 100 x 50 x 6	6.91	10.29	34.41	66.10	43.16	18.47	30.16	10.75
L 100 x 50 x 8	9.09	11.16	35.49	65.28	43.96	19.55	29.59	11.53
L 100 x 50 x 10	11.20	11.97	36.43	64.58	44.58	20.47	29.18	12.26
L 100 x 65 x 6	7.66	14.55	31.49	68.90	48.30	25.43	35.15	16.28
L 100 x 65 x 7	8.85	15.01	32.03	68.58	48.63	26.06	34.89	16.61
L 100 x 65 x 8	10.0	15.44	32.51	68.29	48.90	26.63	34.70	16.92
L 100 x 65 x 9	11.1	15.86	32.98	68.03	49.14	27.17	34.56	17.23
L 100 x 65 x 10	12.29	16.26	33.42	67.79	49.36	27.68	34.45	17.54
L 100 x 75 x 6	8.10	17.71	29.83	70.10	53.58	29.81	36.81	21.10
L 100 x 75 x 7	9.35	18.17	30.35	69.86	53.82	30.47	36.61	21.35
L 100 x 75 x 8	10.70	18.61	30.83	69.66	54.03	31.08	36.48	21.60
L 100 x 75 x 9	11.9	19.03	31.28	69.47	54.20	31.66	36.40	21.86
L 100 x 75 x 10	13.07	19.44	31.71	69.30	54.36	32.21	36.36	22.11
L 120 x 80 x 6	9.28	17.61	37.00	83.17	58.73	30.86	42.90	20.25
L 120 x 80 x 8	12.20	18.54	38.07	82.54	59.38	32.15	42.38	20.88
L 120 x 80 x 10	14.90	19.38	39.00	82.04	59.86	33.27	42.08	21.49
L 130 x 65 x 6	9.07	12.62	43.94	86.50	55.56	23.13	39.80	13.43
L 130 x 65 x 8	11.80	13.54	45.14	85.56	56.53	24.35	39.07	14.25
L 130 x 65 x 10	14.60	14.39	46.16	84.79	57.26	25.38	38.56	15.00
L 130 x 75 x 6	9.54	15.37	41.92	88.46	58.50	27.74	43.52	16.88
L 130 x 75 x 8	12.54	16.30	43.08	87.64	59.36	29.03	42.83	17.63
L 130 x 75 x 10	15.47	17.16	44.07	86.97	60.00	30.12	42.39	18.33
L 130 x 90 x 10	16.65	21.70	41.31	89.56	66.29	37.12	46.38	24.55
L 130 x 90 x 12	19.76	22.52	42.19	89.13	66.68	38.19	46.20	25.13
L 140 x 90 x 8	14.13	20.02	44.34	96.18	67.37	35.19	48.96	22.49
L 140 x 90 x 10	17.46	20.90	45.35	95.57	67.97	36.39	48.53	23.14
L 140 x 90 x 12	20.72	21.73	46.27	95.05	68.44	37.45	48.24	23.76
L 150 x 75 x 8	13.80	15.08	51.41	99.24	64.72	27.41	45.48	15.97
L 150 x 75 x 9	15.4	15.95	53.43	97.41	66.88	29.22	45.33	18.02
L 150 x 75 x 10	16.80	15.96	52.51	98.36	65.56	28.53	44.86	16.75
L 150 x 75 x 11	18.6	16.50	53.50	97.50	66.50	29.50	43.70	16.80
L 150 x 75 x 12	20.2	17.09	54.57	96.64	67.46	30.35	45.02	19.03
L 150 x 75 x 15	24.8	18.21	55.70	95.87	68.03	31.44	44.73	20.03
L 150 x 90 x 8	14.57	19.89	49.88	100.80	71.11	35.96	50.94	23.30
L 150 x 90 x 9	16.44	19.95	49.50	101.29	70.36	35.58	50.44	22.17
L 150 x 90 x 10	18.17	20.16	49.45	101.48	70.02	35.58	50.33	21.95
L 150 x 90 x 11	19.9	20.59	49.94	101.17	70.32	36.13	50.13	22.28
L 150 x 90 x 12	21.59	21.00	50.41	100.88	70.58	36.66	49.96	22.62
L 150 x 90 x 15	26.49	22.49	52.49	99.40	72.12	38.83	50.70	25.44
L 150 x 100 x 8	15.5	22.20	46.41	103.90	73.45	38.78	53.53	25.37
L 150 x 100 x 9	17.03	23.37	48.36	102.34	75.39	41.05	53.62	27.98
L 150 x 100 x 10	19.08	23.12	47.48	103.27	74.11	40.08	52.99	25.99
L 150 x 100 x 12	22.5	23.98	48.45	102.74	74.62	41.23	52.65	26.60

角鐵(不等邊) (續) Unequal Angles (Continued)

Profiles are laser fused with full penetration, equivalent to hot rolled. 型材採用激光熔透，等同於熱軋。

- 尺寸: 符合BS EN 10056-1:1999
- 公差: BS EN 10056-2:1993 • 等級: 符合BS EN 10025-2:2004
- Dimension: in accordance with BS EN 10056-1:1999
- Tolerance: BS EN 10056-2:1993 • Grade: according to BS EN 10025-2:2004

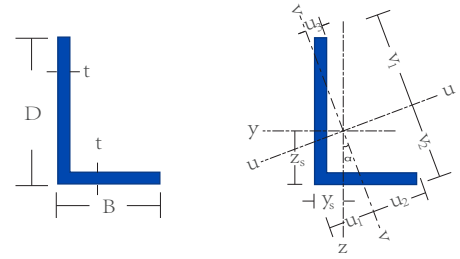

尺寸 Size	單位重量 Mass per Unit Length	y_s	z_s	v_1	v_2	u_1	u_2	u_3
D x B x t (mm)	kg/m	mm	mm	mm	mm	mm	mm	mm
L 150 x 100 x 14	26.1	25.00	49.80	101.90	75.50	42.80	52.20	27.50
L 150 x 100 x 15	27.8	25.58	50.57	101.37	76.09	43.65	53.70	29.70
L 160 x 100 x 8	14.81	15.84	54.53	106.10	68.78	28.92	48.71	16.82
L 160 x 100 x 10	18.30	16.74	55.68	105.21	69.68	30.08	48.03	17.62
L 160 x 100 x 12	21.72	17.59	56.69	104.44	70.41	31.11	47.53	18.38
L 180 x 90 x 8	16.73	17.41	60.95	119.63	77.14	32.08	55.10	18.65
L 180 x 90 x 10	20.68	18.33	62.15	118.69	78.11	33.31	54.36	19.47
L 180 x 90 x 12	24.58	19.20	63.20	117.89	78.88	34.37	53.81	20.24
L 200 x 100 x 8	18.68	18.91	67.11	133.42	85.18	35.02	61.64	20.34
L 200 x 100 x 10	23.00	19.87	68.41	132.37	86.29	36.36	60.78	21.18
L 200 x 100 x 12	27.30	20.76	69.53	131.51	87.15	37.50	60.14	21.98
L 200 x 100 x 14	31.6	21.80	71.20	130.10	88.60	39.10	58.50	22.40
L 200 x 100 x 15	33.8	22.03	71.03	130.39	88.20	39.01	59.41	23.11
L 200 x 100 x 16	35.9	22.44	71.50	130.05	88.51	39.47	59.20	23.47
L 200 x 150 x 12	32.18	35.76	60.23	139.75	107.72	60.30	73.43	42.75
L 200 x 150 x 15	39.78	37.05	61.63	139.17	108.29	62.10	73.11	43.52

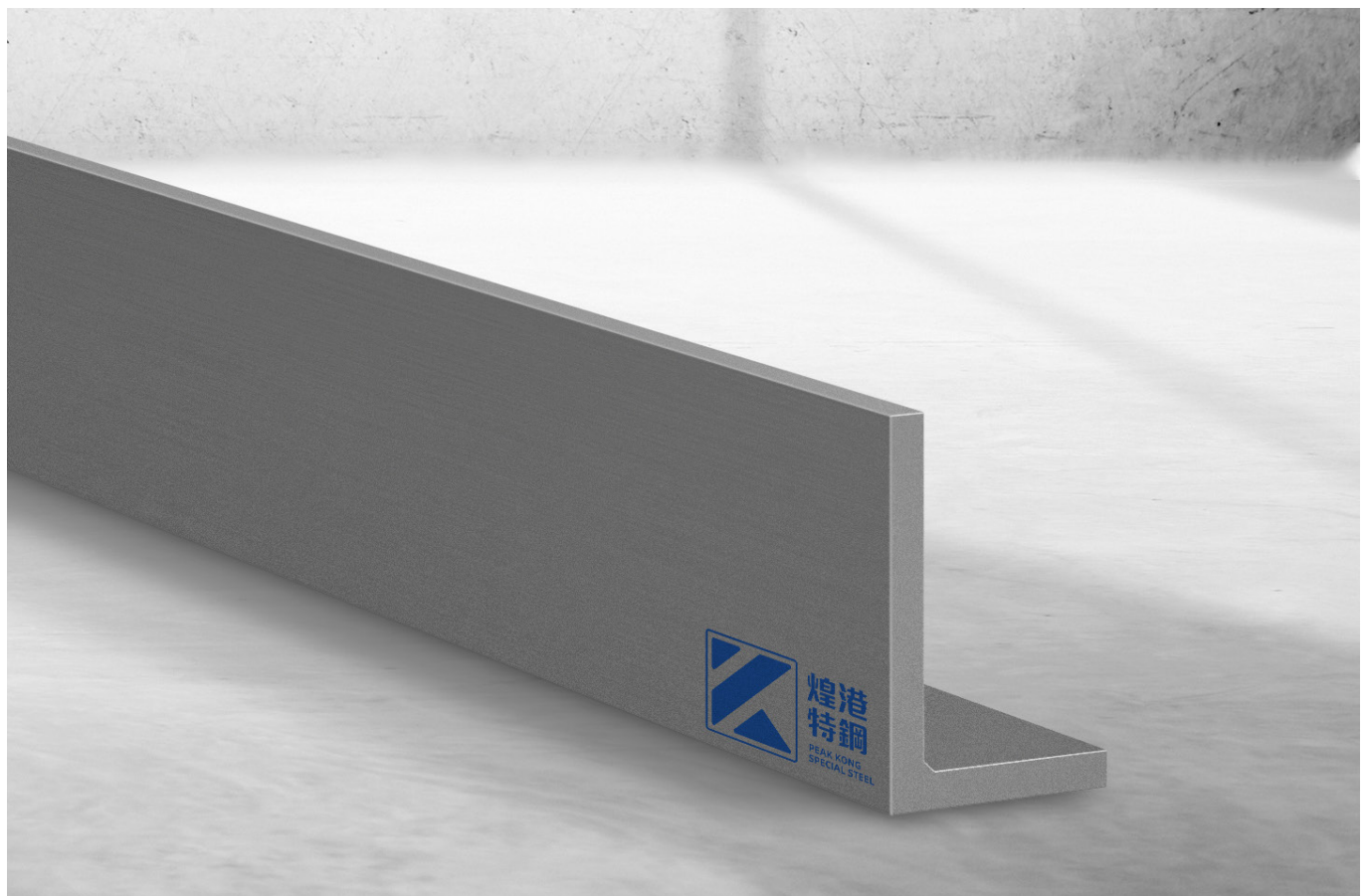

槽鋼 (PFC) Channels (PFC)

Profiles are laser fused with full penetration, equivalent to hot rolled.

- 尺寸: 符合BS 4-1: 1993
- 公差: EN 10279:2000 • 等級: 符合BS EN 10025-2:2004
- Dimension: in accordance with BS 4-1: 1993
- Tolerance: EN 10279:2000 • Grade: according to BS EN 10025-2:2004

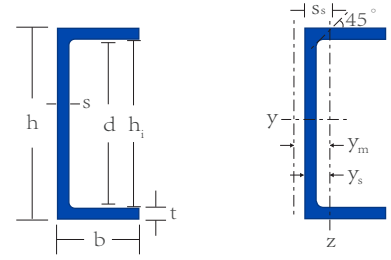

尺寸 Designation	單位重量 Mass per Unit Length	高度 Depth of Section	寬度 Width of Section	腰厚 Web Thickness	腿厚 Flange Thickness	h ₁ (mm)	d(mm)
	kg/m	h(mm)	b(mm)	s(mm)	t(mm)		
PFC 100 x 50 x 10	10.2	100	50	5	8.5	83	79
PFC 125 x 65 x 15	14.8	125	65	5.5	9.5	106	102
PFC 150 x 75 x 18	17.9	150	75	5.5	10	130	126
PFC 150 x 90 x 24	23.9	150	90	6.5	12	126	122
PFC 180 x 75 x 20	20.3	180	75	6	10.5	159	155
PFC 180 x 90 x 26	26.1	180	90	6.5	12.5	155	151
PFC 200 x 75 x 23	23.4	200	75	6	12.5	175	171
PFC 200 x 90 x 30	29.7	200	90	7	14	172	168
PFC 230 x 75 x 26	25.7	230	75	6.5	12.5	205	201
PFC 230 x 90 x 32	32.2	230	90	7.5	14	202	198
PFC 260 x 75 x 28	27.6	260	75	7	12	236	232
PFC 260 x 90 x 35	34.8	260	90	8	14	232	228
PFC 300 x 90 x 41	41.4	300	90	9	15.5	269	265
PFC 300 x 100 x 46	45.5	300	100	9	16.5	267	263
PFC 380 x 100 x 54	54.0	380	100	9.5	17.5	345	341
PFC 430 x 100 x 64	64.4	430	100	11	19	392	388

尺寸 Designation	I _y	W _{el,y}	W _{pl,y}	i _y	A _{vz}	I _z	W _{el,z}	W _{pl,z}	i _z	S _s	I _t	I _w	y _s	y _m
	mm ⁴ x 10 ⁴	mm ³ x 10 ³	mm ³ x 10 ³	mm x 10	mm ² x 10 ²	mm ⁴ x 10 ⁴	mm ³ x 10 ³	mm ³ x 10 ³	mm x 10	mm	mm ⁴ x 10 ⁴	mm ⁶ x 10 ⁹	mm ⁶ x 10 ⁹	mm ⁶ x 10 ⁹
PFC 100 x 50 x 10	202.54	40.51	47.64	4.00	4.76	31.92	9.85	11.15	1.59	14.68	2.38	0.37	1.76	3.48
PFC 125 x 65 x 15	467.87	74.86	86.95	5.07	6.56	78.71	18.71	20.88	2.08	16.18	4.26	1.45	2.29	4.63
PFC 150 x 75 x 18	837.66	111.69	128.46	6.15	7.92	129.00	26.47	29.12	2.41	16.68	5.63	3.45	2.63	5.39
PFC 150 x 90 x 24	1139.99	152.00	175.05	6.18	9.23	249.66	44.19	49.94	2.89	19.68	11.27	6.94	3.35	6.78
PFC 180 x 75 x 20	1334.76	148.31	171.67	7.26	10.40	144.86	28.67	30.97	2.39	17.68	6.84	5.30	2.45	5.07
PFC 180 x 90 x 26	1783.82	198.20	227.74	7.40	11.15	273.58	47.23	52.27	2.90	20.18	12.79	10.65	3.21	6.57
PFC 200 x 75 x 23	1919.66	191.97	222.02	8.10	11.52	168.35	33.74	36.74	2.40	19.68	10.60	7.72	2.51	5.17
PFC 200 x 90 x 30	2481.75	248.17	286.43	8.16	13.32	310.96	53.22	58.82	2.89	22.18	17.78	14.71	3.16	6.44
PFC 230 x 75 x 26	2688.36	233.77	272.55	9.15	14.40	179.76	34.74	37.33	2.37	20.18	11.29	10.39	2.33	4.82
PFC 230 x 90 x 32	3460.33	300.90	349.01	9.26	16.50	331.85	54.85	59.56	2.87	22.68	18.76	19.84	2.95	6.08
PFC 260 x 75 x 28	3538.96	272.23	321.07	10.12	17.62	184.65	34.33	36.65	2.31	20.18	11.17	12.97	2.12	4.43
PFC 260 x 90 x 35	4651.39	357.80	418.00	10.31	19.98	350.79	56.22	60.43	2.83	23.18	20.00	25.73	2.76	5.72
PFC 300 x 90 x 41	7114.14	474.28	560.15	11.68	25.93	402.60	63.08	68.24	2.78	25.68	28.24	38.11	2.62	5.38
PFC 300 x 100 x 46	8068.80	537.92	628.63	11.89	25.86	564.53	81.60	87.92	3.15	26.68	35.36	55.26	3.08	6.37
PFC 380 x 100 x 54	14762.93	777.00	917.65	14.76	34.80	640.72	89.13	95.30	3.07	28.18	44.17	95.82	2.81	5.86
PFC 430 x 100 x 64	21587.15	1004.05	1204.15	16.31	45.61	721.03	97.89	106.88	2.98	31.18	61.45	133.73	2.63	5.40

槽鋼 Channels

Profiles are laser fused with full penetration, equivalent to hot rolled.

- 尺寸: 符合BS 4-1: 1993
- 公差: EN 10279:2000 • 等級: 符合BS EN 10025-2:2004
- Dimension: in accordance with BS 4-1: 1993
- Tolerance: EN 10279:2000 • Grade: according to BS EN 10025-2:2004

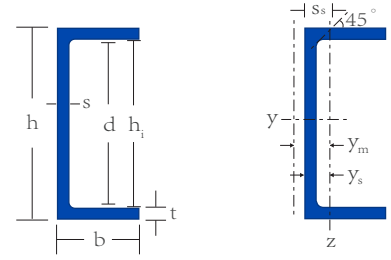

尺寸 Designation	單位重量 Mass per Unit Length	高度 Depth of Section	寬度 Width of Section	腰厚 Web Thickness	腿厚 Flange Thickness
	kg/m	h(mm)	b(mm)	s(mm)	t(mm)
CH 76 x 38 x 7	6.7	76.2	38.1	5.1	6.8
CH 102 x 51 x 10	10.4	101.6	50.8	6.1	7.6
CH 127 x 64 x 15	14.9	127	63.5	6.4	9.2
CH 152 x 76 x 18	17.9	152.4	76.2	6.4	9
CH 152 x 89 x 24	23.9	152.4	88.9	7.1	11.6
CH 178 x 76 x 21	20.8	177.8	76.2	6.6	10.3
CH 178 x 89 x 27	26.8	177.8	88.9	7.6	12.3
CH 203 x 76 x 24	23.9	203.2	76.2	7.1	11.2
CH 203 x 89 x 30	29.8	203.2	88.9	8.1	12.9
CH 229 x 76 x 26	26.1	228.6	76.2	7.6	11.2
CH 229 x 89 x 33	32.7	228.6	88.9	8.6	13.3
CH 245 x 76 x 28	28.2	254	76.2	8.1	10.9
CH 245 x 89 x 36	35.7	254	88.9	9.1	13.6
CH 305 x 89 x 42	41.8	304.8	88.9	10.2	13.7
CH 305 x 102 x 46	46.2	304.8	101.6	10.2	14.8
CH 305 x 102 x 55	55.0	381	101.6	10.4	16.3
CH 432 x 102 x 65	65.5	431.8	101.6	12.2	16.8

尺寸 Designation	I_y	W_{ely}	W_{ply}	i_y	A_{vz}	I_z	W_{elz}	W_{plz}	i_z	S_s	I_t	I_w	y_s	y_m
	$mm^4 \times 10^4$	$mm^3 \times 10^3$	$mm^3 \times 10^3$	$mm \times 10$	$mm^2 \times 10^2$	$mm^4 \times 10^4$	$mm^3 \times 10^3$	$mm^3 \times 10^3$	$mm \times 10$	mm	$mm^4 \times 10^4$	$mm^6 \times 10^9$	$mm^6 \times 10^9$	$mm^6 \times 10^9$
CH 76 x 38 x 7	75.1	19.71	23.7	2.95	4.34	10.1	3.78	7.5	1.08	19.1	1.64	0.09	1.12	2.07
CH 102 x 51 x 10	206	40.51	48.7	3.95	6.62	27.7	7.64	14.9	1.45	21.3	2.89	0.44	1.42	2.71
CH 127 x 64 x 15	477	75.09	89.1	5.04	8.73	64.7	14.5	27.7	1.86	24.2	5.21	1.58	1.82	3.57
CH 152 x 76 x 18	838	110	129	6.11	10.48	109	20	38.3	2.21	25.0	6.24	3.95	2.04	4.12
CH 152 x 89 x 24	1154	151.4	177	6.20	11.90	210	34.5	63.7	2.64	29.8	12.9	7.21	2.67	5.34
CH 178 x 76 x 21	1329	149.5	176	7.10	12.75	129	23.6	45.3	2.21	27.5	8.87	6.39	2.05	4.14
CH 178 x 89 x 27	1735	195.2	229	7.17	14.70	234	37.7	70.9	2.63	31.5	15.8	11.1	2.58	5.16
CH 203 x 76 x 24	1948	191.7	227	8.02	15.57	146	26.3	50.8	2.20	29.4	11.5	9.55	2.00	4.02
CH 203 x 89 x 30	2469	243	286	8.10	17.68	256	40.6	77.2	2.61	32.8	18.8	16.1	2.48	4.98
CH 229 x 76 x 26	2608	228.1	272	8.87	18.50	152	26.7	51.7	2.14	30.1	12.8	13.0	1.87	3.76
CH 229 x 89 x 33	3364	294.3	349	9.01	21.05	274	42.5	81.9	2.57	34.4	22.0	22.4	2.37	4.75
CH 245 x 76 x 28	3361	264.6	319	9.67	21.78	153	26.1	51.2	2.06	31.0	14.4	16.9	1.73	3.44
CH 245 x 89 x 36	4435	349.2	416	9.89	24.65	289	44.1	85.2	2.53	35.9	25.6	30.0	2.27	4.52
CH 305 x 89 x 42	7036	461.7	572	11.52	33.74	304	44.5	92.9	2.40	39.6	39.9	57.2	2.10	4.19
CH 305 x 102 x 46	8078	530	652	11.79	34.17	472	61.7	128	2.85	41.6	49.5	86.3	2.56	5.25
CH 305 x 102 x 55	14730	773.1	952	14.55	43.17	546	70.3	145	2.80	44.1	62.8	157	2.43	4.99
CH 432 x 102 x 65	20970	971.2	1220	16.0	55.26	599	75.6	153	2.70	44.1	74.4	222	2.27	4.53

T型鋼(等邊) Equal Flange Tees

Profiles are laser fused with full penetration, equivalent to hot rolled. 型材採用激光熔透，等同於熱軋。

- 尺寸和公差：符合BS EN 10055 • 等級：符合BS EN 10025-2:2004
- Dimension and tolerance: in accordance with BS EN 10055
- Grade: according to BS EN 10025-2:2004

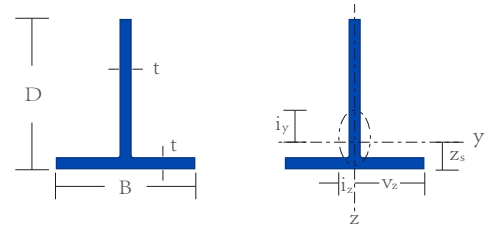

尺寸 Designation	單位重量 Mass per Unit Length	Z_s	I_y	W_{ely}	i_y	I_z	W_{elz}	i_z
	kg/m							
T 20 x 20 x 3	0.89	6.05	0.40	0.29	0.60	0.20	0.20	0.43
T 20 x 20 x 4	1.15	6.42	0.50	0.37	0.59	0.28	0.28	0.43
T 25 x 25 x 3	1.12	7.30	0.82	0.47	0.76	0.40	0.32	0.53
T 25 x 25 x 3.5	1.29	7.49	0.93	0.53	0.75	0.46	0.37	0.53
T 25 x 25 x 4	1.46	7.68	1.04	0.60	0.75	0.53	0.43	0.54
T 30 x 30 x 3	1.36	8.55	1.46	0.68	0.92	0.68	0.45	0.63
T 30 x 30 x 4	1.78	8.93	1.86	0.88	0.91	0.91	0.61	0.64
T 30 x 30 x 5	2.17	9.29	2.22	1.07	0.90	1.15	0.77	0.65
T 35 x 35 x 3	1.59	9.80	2.37	0.94	1.08	1.08	0.62	0.73
T 35 x 35 x 4	2.09	10.18	3.03	1.22	1.07	1.45	0.83	0.74
T 35 x 35 x 5	2.57	10.55	3.64	1.49	1.06	1.82	1.04	0.75
T 40 x 40 x 3	1.83	11.05	3.59	1.24	1.24	1.61	0.80	0.83
T 40 x 40 x 4	2.40	11.43	4.62	1.62	1.23	2.15	1.08	0.84
T 40 x 40 x 5	2.96	11.80	5.57	1.97	1.22	2.70	1.35	0.85
T 40 x 40 x 6	3.50	12.17	6.45	2.32	1.20	3.26	1.63	0.86
T 45 x 45 x 3	2.06	12.30	5.18	1.58	1.40	2.29	1.02	0.93
T 45 x 45 x 4	2.72	12.69	6.68	2.07	1.39	3.06	1.36	0.94
T 45 x 45 x 5	3.35	13.06	8.08	2.53	1.38	3.84	1.71	0.95
T 45 x 45 x 6	3.97	13.42	9.40	2.98	1.36	4.63	2.06	0.96
T 50 x 50 x 3	2.30	13.55	7.17	1.97	1.56	3.14	1.25	1.04
T 50 x 50 x 4	3.03	13.94	9.28	2.57	1.55	4.19	1.68	1.04
T 50 x 50 x 5	3.74	14.31	11.26	3.16	1.54	5.26	2.10	1.05
T 50 x 50 x 6	4.44	14.68	13.14	3.72	1.52	6.33	2.53	1.06
T 50 x 50 x 7	5.13	15.04	14.91	4.26	1.51	7.42	2.97	1.07
T 50 x 50 x 8	5.79	15.40	16.57	4.79	1.50	8.51	3.41	1.07
T 60 x 60 x 5	4.53	16.81	19.93	4.61	1.86	9.06	3.02	1.25
T 60 x 60 x 6	5.39	17.18	23.35	5.45	1.85	10.90	3.63	1.26
T 60 x 60 x 7	6.23	17.55	26.60	6.27	1.83	12.75	4.25	1.27
T 60 x 60 x 8	7.05	17.91	29.70	7.06	1.82	14.62	4.87	1.28
T 60 x 60 x 10	8.65	18.62	35.47	8.57	1.79	18.42	6.14	1.29
T 65 x 65 x 5	4.92	18.07	25.57	5.45	2.02	11.51	3.54	1.35
T 65 x 65 x 6	5.86	18.44	30.01	6.45	2.01	13.84	4.26	1.36
T 65 x 65 x 7	6.77	18.80	34.25	7.41	1.99	16.19	4.98	1.37
T 65 x 65 x 8	7.68	19.17	38.30	8.36	1.98	18.55	5.71	1.38
T 65 x 65 x 9	8.56	19.53	42.18	9.28	1.97	20.94	6.44	1.39
T 65 x 65 x 10	9.44	19.88	45.89	10.17	1.95	23.34	7.18	1.39
T 70 x 70 x 5	5.31	19.32	32.19	6.35	2.18	14.36	4.10	1.46
T 70 x 70 x 6	6.33	19.69	37.84	7.52	2.17	17.27	4.93	1.46
T 70 x 70 x 7	7.32	20.06	43.25	8.66	2.15	20.19	5.77	1.47
T 70 x 70 x 8	8.31	20.42	48.43	9.77	2.14	23.13	6.61	1.48
T 70 x 70 x 9	9.27	20.78	53.41	10.85	2.13	26.10	7.46	1.49
T 70 x 70 x 10	10.22	21.14	58.18	11.91	2.11	29.08	8.31	1.49
T 75 x 75 x 5	5.71	20.57	39.87	7.32	2.34	17.65	4.71	1.56
T 75 x 75 x 6	6.80	20.94	46.92	8.68	2.33	21.22	5.66	1.57
T 75 x 75 x 7	7.87	21.31	53.70	10.00	2.31	24.80	6.61	1.57
T 75 x 75 x 8	8.93	21.67	60.21	11.29	2.30	28.41	7.58	1.58

T型鋼(等邊)(續) Equal Flange Tees (Continued)

Profiles are laser fused with full penetration, equivalent to hot rolled. 型材採用激光熔透，等同於熱軋。

- 尺寸和公差：符合BS EN 10055 • 等級：符合BS EN 10025-2:2004
- Dimension and tolerance: in accordance with BS EN 10055
- Grade: according to BS EN 10025-2:2004

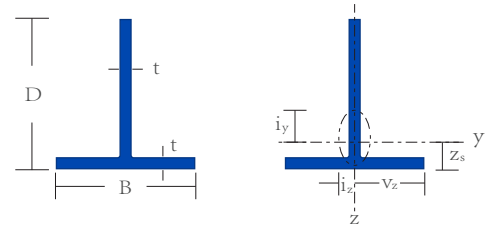

尺寸 Designation	單位重量 Mass per Unit Length	Z_s	I_y	W_{ely}	i_y	I_z	W_{elz}	i_z
	kg/m							
T 75 x 75 x 9	9.98	22.04	66.48	12.55	2.29	32.04	8.54	1.59
T 75 x 75 x 10	11.01	22.40	72.50	13.78	2.27	35.70	9.52	1.60
T 80 x 80 x 5	6.10	21.82	48.68	8.37	2.50	21.41	5.35	1.66
T 80 x 80 x 6	7.27	22.19	57.35	9.92	2.49	25.73	6.43	1.67
T 80 x 80 x 7	8.42	22.56	65.71	11.44	2.48	30.08	7.52	1.67
T 80 x 80 x 8	9.56	22.93	73.77	12.92	2.46	34.44	8.61	1.68
T 80 x 80 x 9	10.68	23.29	81.53	14.38	2.45	38.83	9.71	1.69
T 80 x 80 x 10	11.79	23.65	89.01	15.80	2.43	43.25	10.81	1.70
T 90 x 90 x 6	8.21	24.69	82.64	12.65	2.81	36.60	8.13	1.87
T 90 x 90 x 7	9.52	25.06	94.87	14.61	2.80	42.76	9.50	1.88
T 90 x 90 x 8	10.82	25.43	106.70	16.53	2.78	48.95	10.88	1.88
T 90 x 90 x 9	12.10	25.80	118.15	18.40	2.77	55.17	12.26	1.89
T 90 x 90 x 10	13.36	26.16	129.22	20.24	2.76	61.42	13.65	1.90
T 100 x 100 x 6	9.15	27.20	114.46	15.72	3.13	50.17	10.03	2.07
T 100 x 100 x 7	10.62	27.57	131.60	18.17	3.12	58.60	11.72	2.08
T 100 x 100 x 8	12.07	27.94	148.24	20.57	3.10	67.06	13.41	2.09
T 100 x 100 x 9	13.51	28.30	164.39	22.93	3.09	75.55	15.11	2.10
T 100 x 100 x 10	14.93	28.67	180.06	25.24	3.08	84.08	16.82	2.10
T 100 x 100 x 12	17.73	29.39	210.06	29.75	3.05	101.27	20.25	2.12
T 110 x 110 x 6	10.10	29.70	153.56	19.12	3.46	66.74	12.13	2.28
T 110 x 110 x 7	11.72	30.07	176.78	22.12	3.44	77.94	14.17	2.28
T 110 x 110 x 8	13.33	30.44	199.38	25.06	3.43	89.17	16.21	2.29
T 110 x 110 x 9	14.92	30.81	221.37	27.95	3.41	100.44	18.26	2.30
T 110 x 110 x 10	16.50	31.17	242.78	30.80	3.40	111.75	20.32	2.31
T 110 x 110 x 11	18.06	31.54	263.61	33.60	3.38	123.11	22.38	2.31
T 110 x 110 x 12	19.61	31.90	283.90	36.35	3.37	134.51	24.46	2.32
T 120 x 120 x 7	12.82	32.57	231.28	26.45	3.76	101.12	16.85	2.49
T 120 x 120 x 8	14.59	32.94	261.12	29.99	3.75	115.68	19.28	2.50
T 120 x 120 x 9	16.34	33.31	290.23	33.48	3.73	130.28	21.71	2.50
T 120 x 120 x 10	18.07	33.68	318.62	36.91	3.72	144.92	24.15	2.51
T 120 x 120 x 11	19.79	34.04	346.32	40.29	3.71	159.61	26.60	2.52
T 120 x 120 x 12	21.49	34.41	373.34	43.62	3.69	174.36	29.06	2.52
T 120 x 120 x 13	23.18	34.77	399.71	46.90	3.68	189.16	31.53	2.53
T 120 x 120 x 15	26.51	35.49	450.55	53.31	3.65	218.95	36.49	2.55
T 130 x 130 x 8	15.84	35.45	334.46	35.37	4.07	146.99	22.61	2.70
T 130 x 130 x 9	17.75	35.81	372.08	39.50	4.06	165.51	25.46	2.71
T 130 x 130 x 10	19.64	36.18	408.84	43.58	4.04	184.08	28.32	2.71
T 130 x 130 x 11	21.52	36.55	444.77	47.59	4.03	202.71	31.19	2.72
T 130 x 130 x 12	23.38	36.91	479.88	51.55	4.01	221.40	34.06	2.73
T 130 x 130 x 13	25.22	37.28	514.21	55.46	4.00	240.15	36.95	2.73
T 130 x 130 x 15	28.86	38.00	580.57	63.11	3.97	277.86	42.75	2.75
T 140 x 140 x 8	17.10	37.95	420.41	41.20	4.39	183.50	26.21	2.90
T 140 x 140 x 9	19.16	38.32	468.05	46.03	4.38	206.60	29.51	2.91
T 140 x 140 x 10	21.21	38.69	514.68	50.80	4.36	229.75	32.82	2.92
T 140 x 140 x 11	23.24	39.05	560.33	55.51	4.35	252.97	36.14	2.92
T 140 x 140 x 12	25.26	39.42	605.03	60.15	4.34	276.24	39.46	2.93

T型鋼(等邊)(續) Equal Flange Tees (Continued)

Profiles are laser fused with full penetration, equivalent to hot rolled. 型材採用激光熔透，等同於熱軋。

- 尺寸和公差：符合BS EN 10055 • 等級：符合BS EN 10088-3:1D
- Dimension and tolerance: in accordance with BS EN 10055
- Grade: according to BS EN 10025-2:2004

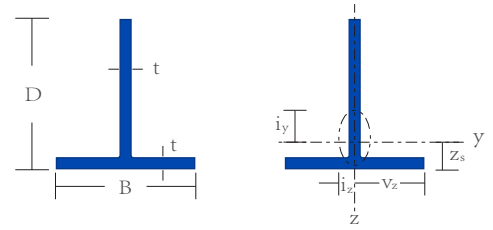

尺寸 Designation	單位重量 Mass per Unit Length	Z_s	I_y	W_{ely}	i_y	I_z	W_{elz}	i_z
	kg/m							
T 140 x 140 x 13	27.26	39.78	648.78	64.74	4.32	299.59	42.80	2.94
T 140 x 140 x 15	31.22	40.51	733.56	73.73	4.29	346.52	49.50	2.95
T 150 x 150 x 6	13.86	39.70	397.72	36.06	4.75	169.01	22.53	3.09
T 150 x 150 x 8	18.35	40.45	519.96	47.46	4.72	225.61	30.08	3.11
T 150 x 150 x 9	20.57	40.82	579.27	53.06	4.70	253.98	33.86	3.11
T 150 x 150 x 10	22.78	41.19	637.41	58.58	4.69	282.42	37.66	3.12
T 150 x 150 x 12	27.15	41.92	750.27	69.42	4.66	339.49	45.27	3.13
T 150 x 150 x 13	29.30	42.29	805.05	74.74	4.64	368.13	49.08	3.14
T 150 x 150 x 15	33.57	43.02	911.40	85.19	4.62	425.67	56.76	3.15
T 150 x 150 x 20	43.98	44.81	1159.75	110.26	4.55	571.17	76.16	3.19
T 160 x 160 x 10	24.35	43.69	778.26	66.91	5.01	342.58	42.82	3.32
T 160 x 160 x 12	29.03	44.43	917.12	79.35	4.98	411.73	51.47	3.34
T 160 x 160 x 13	31.35	44.79	984.64	85.47	4.97	446.43	55.80	3.34
T 160 x 160 x 15	35.93	45.52	1115.96	97.48	4.94	516.08	64.51	3.36
T 160 x 160 x 20	47.12	47.33	1423.86	126.37	4.87	692.00	86.50	3.40
T 180 x 180 x 10	27.49	48.70	1119.34	85.25	5.65	487.42	54.16	3.73
T 180 x 180 x 12	32.80	49.43	1321.62	101.22	5.62	585.62	65.07	3.74
T 180 x 180 x 13	35.43	49.80	1420.28	109.08	5.61	634.86	70.54	3.75
T 180 x 180 x 15	40.64	50.53	1612.75	124.57	5.58	733.64	81.52	3.76
T 180 x 180 x 20	53.40	52.34	2067.08	161.93	5.51	982.67	109.19	3.80
T 200 x 200 x 10	30.63	53.70	1547.93	105.80	6.30	668.25	66.83	4.14
T 200 x 200 x 12	36.57	54.44	1830.54	125.76	6.27	802.71	80.27	4.15
T 200 x 200 x 13	39.51	54.81	1968.70	135.59	6.25	870.09	87.01	4.16
T 200 x 200 x 15	45.35	55.54	2238.91	154.98	6.23	1005.20	100.52	4.17
T 200 x 200 x 20	59.68	57.36	2880.30	201.93	6.16	1345.34	134.53	4.21
T 250 x 250 x 10	38.48	66.20	3067.88	166.92	7.91	1304.08	104.33	5.16
T 250 x 250 x 12	45.99	66.95	3638.35	198.76	7.88	1565.93	125.27	5.17
T 250 x 250 x 13	49.71	67.32	3918.50	214.50	7.87	1697.05	135.76	5.18
T 250 x 250 x 15	57.12	68.05	4468.82	245.61	7.84	1959.74	156.78	5.19
T 250 x 250 x 20	75.38	69.89	5788.41	321.38	7.76	2619.50	209.56	5.22
T 300 x 300 x 10	46.33	78.71	5353.51	241.92	9.52	2252.42	150.16	6.18
T 300 x 300 x 12	55.41	79.45	6361.23	288.43	9.49	2704.15	180.28	6.19
T 300 x 300 x 13	59.92	79.82	6857.57	311.46	9.48	2930.26	195.35	6.20
T 300 x 300 x 15	68.90	80.56	7835.50	357.07	9.45	3383.02	225.53	6.21
T 300 x 300 x 20	91.08	82.40	10196.57	468.60	9.37	4518.67	301.24	6.24

T型鋼(不等邊) Unequal Flange Tees

Profiles are laser fused with full penetration, equivalent to hot rolled.

- 尺寸和公差：符合BS EN 10055 • 等級：符合BS EN 10088-3:1D
- Dimension and tolerance: in accordance with BS EN 10055
- Grade: according to BS EN 10025-2:2004

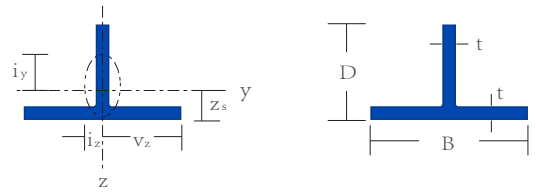

尺寸 Designation	單位重量 Mass per Unit Length	高度 Depth of Section	寬度 Width of Section	腿厚 Flange Thickness
	kg/m	h(mm)	b(mm)	t(mm)
TB 20	1.77	20	40	4
TB 25	2.76	25	50	5
TB 30	3.66	30	60	5.5
TB 35	4.68	35	70	6
TB 40	6.23	40	80	7
TB 50	9.45	50	100	8.5
TB 60	13.36	60	120	10

尺寸 Designation	Z_s	I_y	$W_{el,y}$	i_y	I_z	$W_{el,z}$	i_z
	mm	$mm^4 \times 10^4$	$mm^3 \times 10^3$	mm x 10	$mm^4 \times 10^4$	$mm^3 \times 10^3$	mm x 10
TB 20	4.85	0.62	0.41	0.52	2.14	1.07	0.97
TB 25	6.07	1.50	0.79	0.65	5.23	2.09	1.22
TB 30	7.09	2.91	1.27	0.79	9.93	3.31	1.46
TB 35	8.12	5.11	1.9	0.93	17.20	4.92	1.70
TB 40	9.34	8.87	2.89	1.06	29.96	7.49	1.94
TB 50	11.58	21.16	5.51	1.33	71.05	14.21	2.43
TB 60	13.82	43.18	9.35	1.59	144.42	24.07	2.91

